

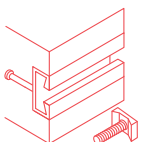

HALFEN

Halfen Detan Rod Systems



Anchoring & Fixing
Rod systems

English

Leviat®

A CRH COMPANY

We imagine, model and make engineered products and innovative construction solutions that help turn architectural visions into reality and enable our construction partners to build better, safer, stronger and faster.

Leviat is a world leader in connecting, fixing, lifting and anchoring technology.

From the build of new schools, hospitals, homes and infrastructure, to the repair and maintenance of heritage structures, our engineering skills are making a difference around the world.

We provide technical design assistance at every stage of a project, from initial planning to installation and beyond.

Our technical support services range from simple product selection through to the development of a fully customised project-specific design solution.

Every promise we make locally, has the commitment and dedication of our global team behind it. We employ almost 3,000 people at 60 locations across North America, Europe and Asia-Pacific, providing an agile and responsive service worldwide.

Leviat, a CRH company, is part of the world's leading building materials business.



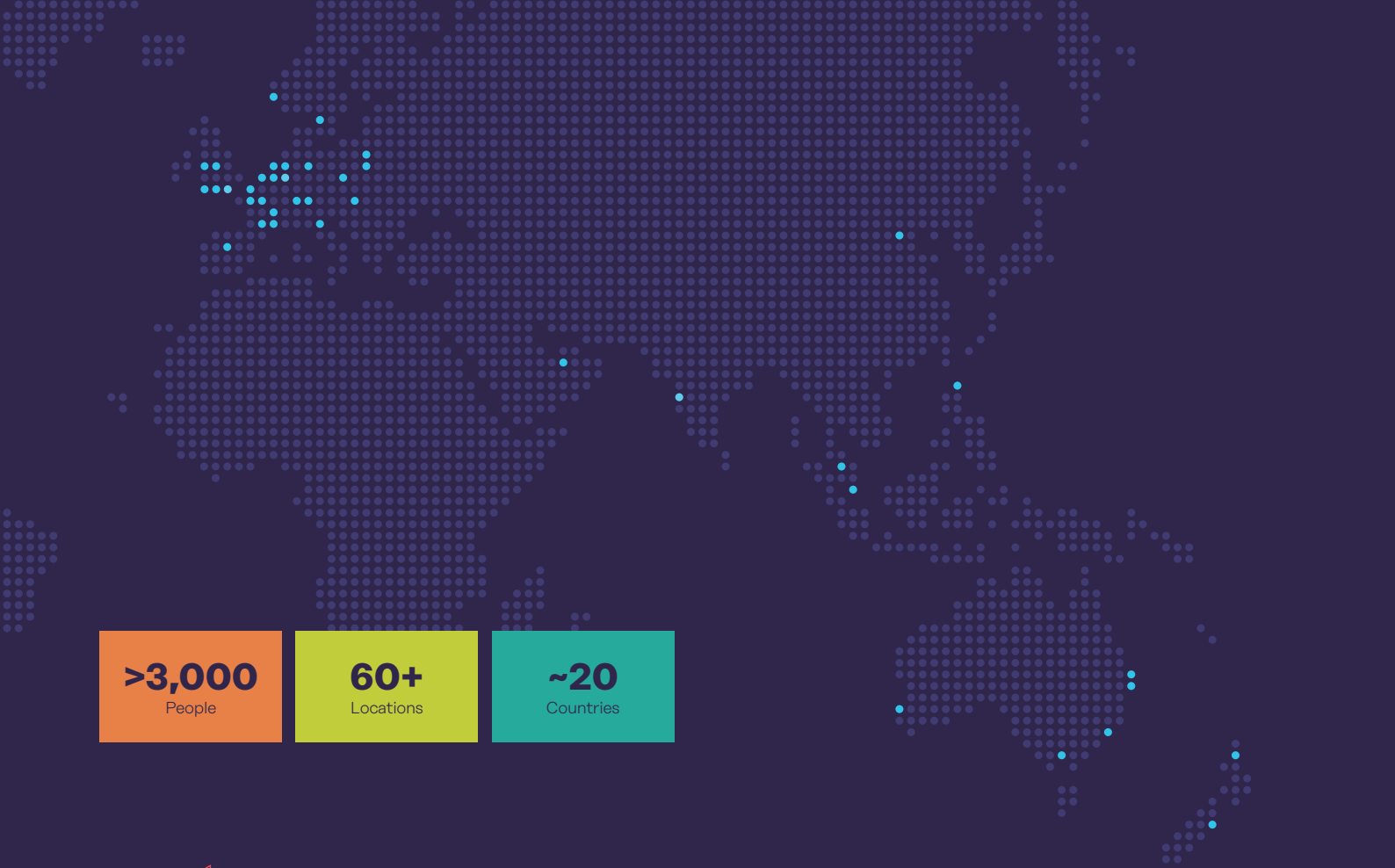

>3,000
People

60+
Locations

~20
Countries

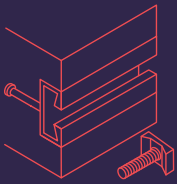

Anchoring & Fixing

Systems for fixing secondary fixtures to concrete, including anchor channels, bolts and inserts; also tension rod systems for roofs and canopies.

- Cast-in Channels, T-Bolts & Accessories
- Threaded Inserts
- Rod Systems
- Attachment Points
- Post Installed Anchor Systems

Other areas of expertise:



Structural Connections

Systems to form robust, efficient connections, and continuity of concrete reinforcement as necessary, between walls, slabs, columns, beams and balconies, providing structural integrity as well as enhanced thermal and acoustic performance.

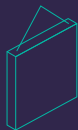

Lifting & Bracing

Systems for the safe and efficient transportation, lifting and temporary bracing of cast concrete elements and tilt-up panels before permanent structural connections are made.



Façade Support & Restraint

Systems for the safe and thermally-efficient fixing of the external building envelope, including brick and natural stone, insulated sandwich panels, curtain walling and suspended concrete façades, and also the repair and strengthening of existing masonry installations.



Formwork & Site Accessories

Non-structural accessories that complement our engineered solutions and help keep your construction environment operating safely and efficiently, including moulds for casting standard and special concrete elements and construction essentials such as reinforcing bar spacers.

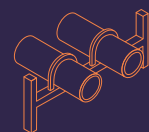

Industrial Technology

Mounting channels, pipe clamps and other versatile framing systems that provide safe fixing in a wide range of industrial applications.

Leviat product ranges:

Ancon | Aschwanden | Connolly | Halfen | Helifix | Isedio | Meadow Burke | Modersohn | Moment | Plaka | Scaldex | Thermomass

Halfen Detan Rod systems

Tension and compression rod system

Modern architecture always strives to find a balance between practical, functional and aesthetically exceptional solutions.

With our Rod Systems, we offer two product solutions that meet the highest aesthetic, safety and quality requirements. Our technically mature systems are easy to install and can be used for filigree supporting structures as well as for high load applications. Rod systems are increasingly being implemented as architectural and structural elements.

As a future-oriented, innovative company Leviat focuses on the ever-changing requirements of the industry. Our latest development aims to combine the portfolio of Ancon and Halfen Rod systems to ensure we meet the individual requirements of our customers and the industry.

For the steel variant we provide "Halfen design" and for the stainless steel variant we provide the "Ancon design". With both systems we are offering to our customers an optimum version from our product portfolio.

Both systems have a wide range of accessories and can be designed as tension and compression rod system. Likewise, both systems are regulated in a European Technical Assessment (ETA). Furthermore, they can be dimensioned and configured in our software, which is available free of charge.

Benefits and changes for planners of the previous Ancon system:

With the Halfen system Detan-S, we offer additional diameters ($d_s = 60$ mm and $d_s = 76$ mm), higher load-bearing capacities and the complete system in steel or hot-dip galvanised steel incl. brushed threads with sealing set.

Benefits or changes for planners of the previous Halfen system Detan-E:

For systems made of stainless steel, larger diameters ($d_s = 36$ mm and $d_s = 42$ mm) can be used. The diameters $d_s = 6$ mm and $d_s = 27$ mm are phased out. In addition to the electropolished variant, it is also possible to obtain satin or hand-polished systems.

Diameters for Halfen Detan-S in steel:

M10, M12, M16, M20, M24, M27, M30, M36, M42, M48, M52, M56, M60, M76

Diameters for Halfen Detan-D in stainless steel:

M8, M10, M12, M16, M20, M24, M30, M36, M42

The market launch of the new product portfolio took place under the following name:

- Halfen Detan-S Rod system carbon steel (previously Detan-S)
- Halfen Detan-D Rod system stainless steel (previously Ancon 500 Stainless steel)



Halfen Detan Rod systems

Tension and compression rod system

Contents

1 Halfen Detan Rod system

Application examples	6
Halfen Detan as a design element	8
System overview and order examples	10

2 Halfen Detan-S Rod system — steel

Halfen Detan-S Tension rods and accessories	16
Halfen Detan-S Connection plates	17
Halfen Detan-S Cross-bracings and Couplers	17

3 Halfen Detan-D Rod system — stainless steel

Halfen Detan-D Tension rods and accessories	18
Halfen Detan-D Connection plates	19
Halfen Detan-D Cross-bracings and Couplers	19

4 Accessories, appendix

Cross-bracings and compression rods	20
Compression rod systems Halfen Detan-S and Halfen Detan-D	21
Surface finishes and coatings	22
Connection plates and installation	23
Corrosion protection	24
On-site logistics	25
Design software	25
European Technical Assessments	26
Pretensioning	27
Tender specification	28
Order forms	30
Addresses / contact	37

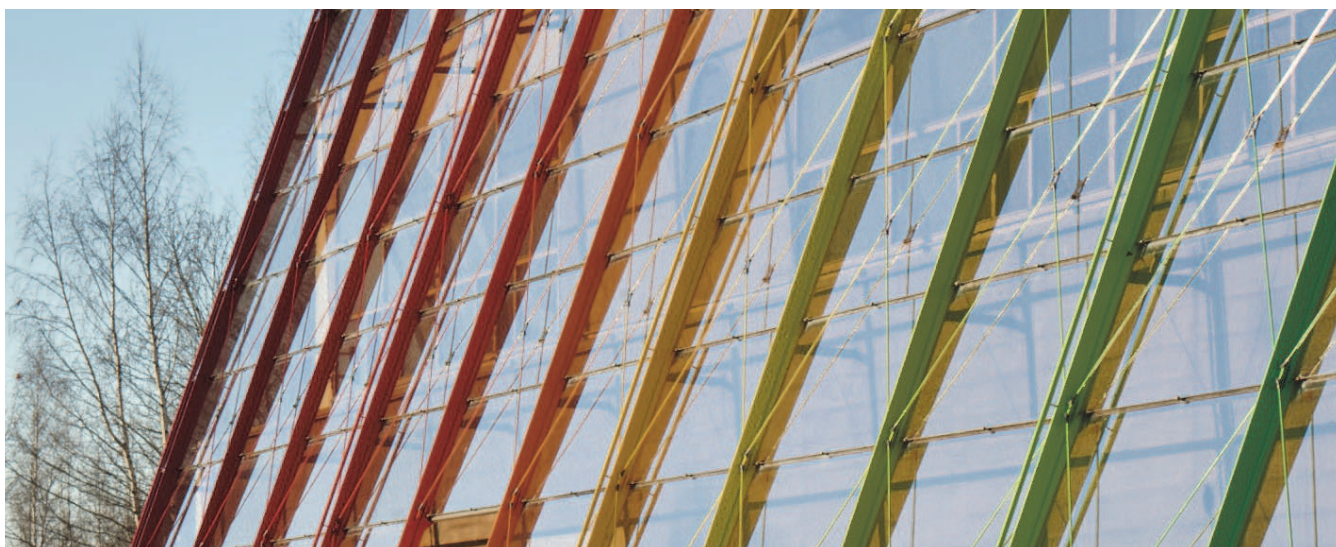

Halfen Detan Rod systems

Applications

Application — examples

The Halfen Detan Tension and compression rod systems are a perfect match, both structurally and aesthetically. Halfen Detan is suitable for use in all types of bracing applications.

To complement range we offer a wide selection of services and accessories, for example, anchor discs and cross couplers and providing construction detailing and assistance for further possible applications.

Bracing under beams

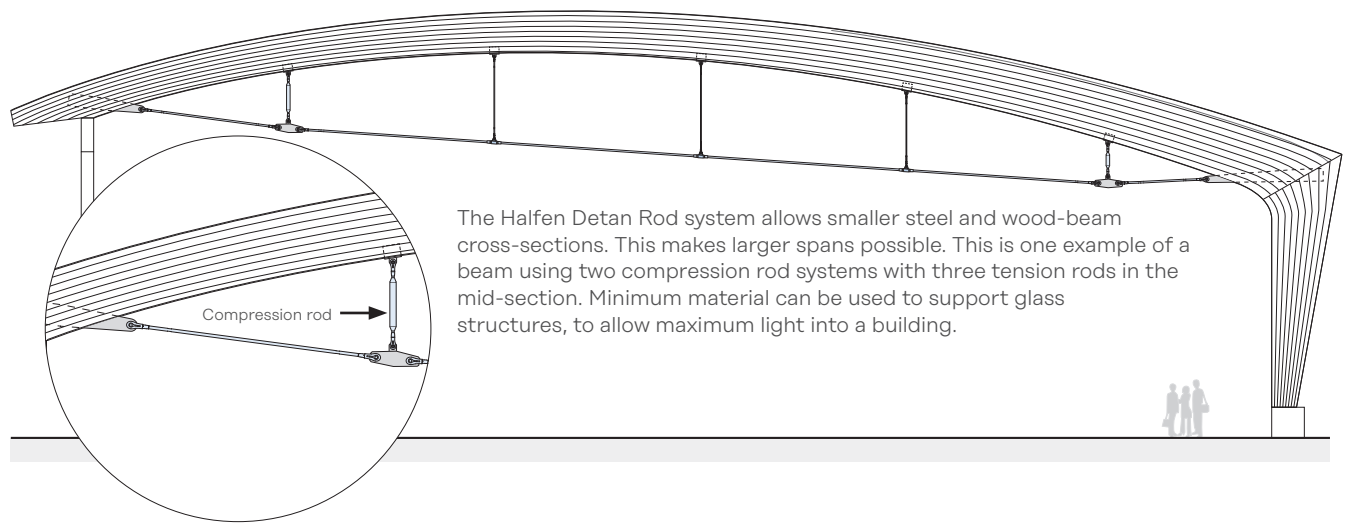

Stiffeners and Bracings

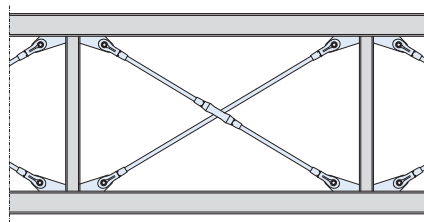
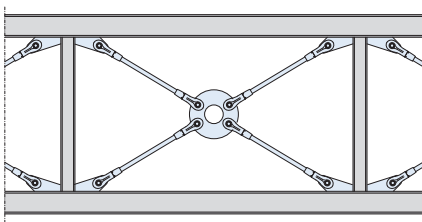

Statically required wind-bracing in roofs and walls can be aesthetically designed as a visual focus-point using the tension rod system. Cross bracing is possible either with a cross coupler or an anchor disc.

Suspensions

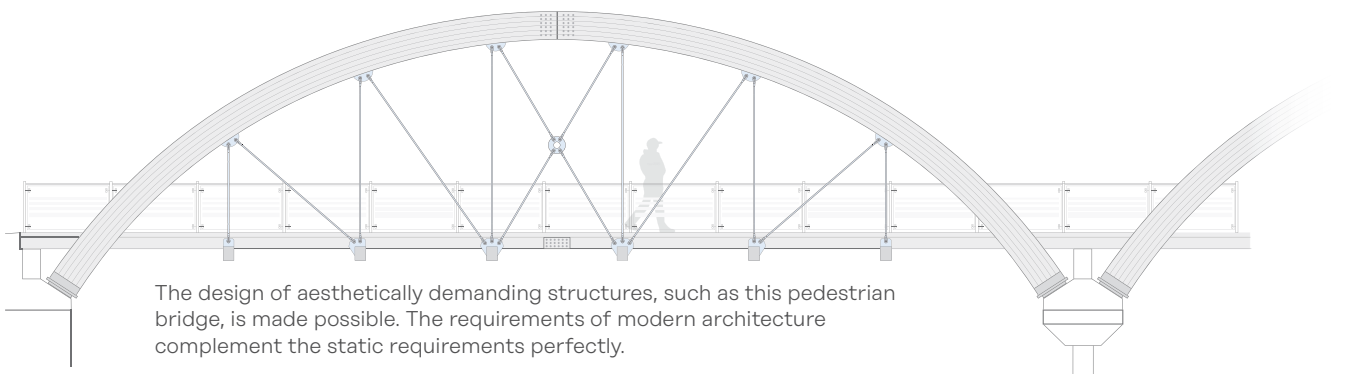

Halfen Detan Rod systems

Applications

Application — examples

Canopy suspensions

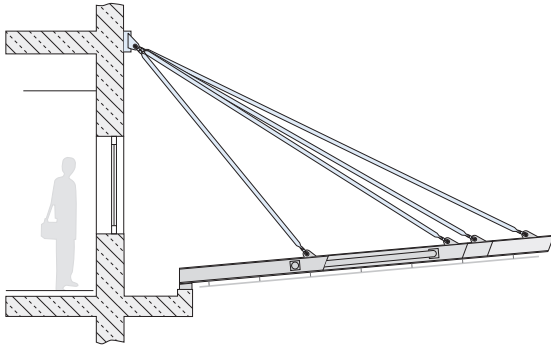

The Halfen Detan System allows bracings to be designed using a minimum of obtrusive structural elements, leaving them almost invisible. Statically required elements are simultaneously used as design elements. The visually, unobtrusive bracing elements give the whole structure an overall lightness. Applications are suspended canopies in all types of commercial and industrial projects. The Halfen Detan Rod system is suitable for tension and compression loads.

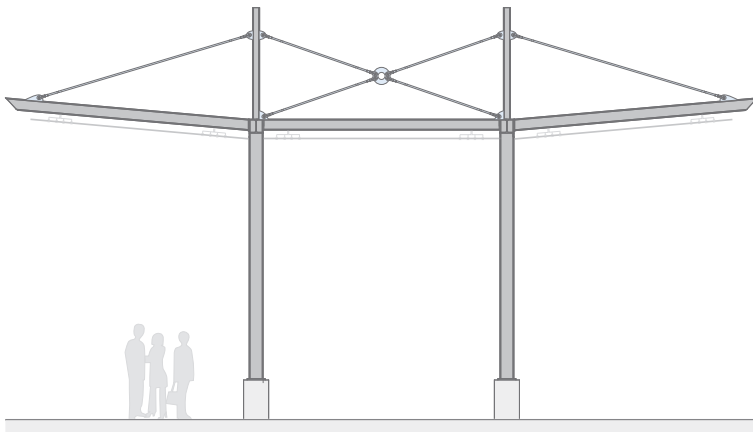

Back-braced glass-façades



The Halfen Detan Rod system allows filigree support structures for glass-façades to be realized.

Halfen Detan Rod systems

Halfen Detan as a Design Element



The Sage, Gateshead/England

Cross bracings provide a futuristic, lightweight construction. For structural reasons, Halfen Detan Tension rods run diagonally across the glazed façade. The filigree Halfen Detan system is perfectly integrated, emphasizing the fascinating overall impression of the building.

Halfen Detan Rod systems

Halfen Detan as a Design Element

L'Aquapolis Centre aquatique, Limoges/France

The aquatic sports centre is located in Limoges in France. Various fun pools are distributed over 2.400 m² as well as a 25 and a 50 metres competition size facility. Numerous fitness, water sport activities and relaxation zones are also available. Construction was completed after 3 years and the centre was opened in January 2015.

In the Aquapolis project the impressive structure uses hot-dipped galvanized elements as tension chords for the roof beams with 12, 16, 24, 30, 36, 56 and 76mm diameters.



Moody Pedestrian Bridge, Austin/USA

The Moody Pedestrian Bridge is a one of a kind inverted Fink Truss Bridge. The bridge is characterized by a series of slender steel towers that vary in height and scale.

Tension rods in various lengths were engineered and designed to connect the towers to the bridge itself. Additional rods were used at the tops of the steel towers and also as a cross brace at the bottom of the main tower. Rods were provided in HDG material and then were painted to match the steel towers.



Halfen Detan Rod systems

System Overview

Halfen Detan Tension rod system

Basic system

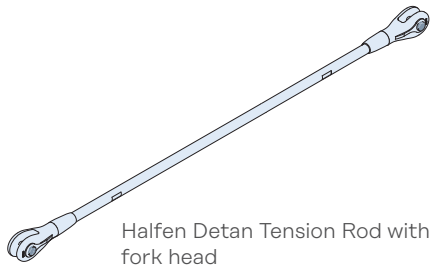

Ordering procedure → page 11
 Load capacity, system dimensions and materials:
 Steel → pages 16–17
 Stainless steel → pages 18–19



The Halfen Detan Rod systems are only approved for predominantly static loads.

System variants

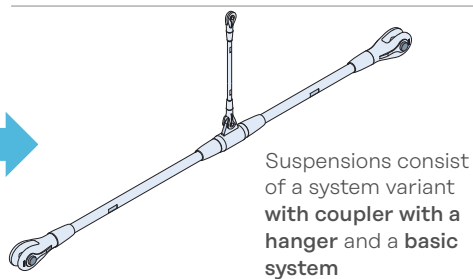
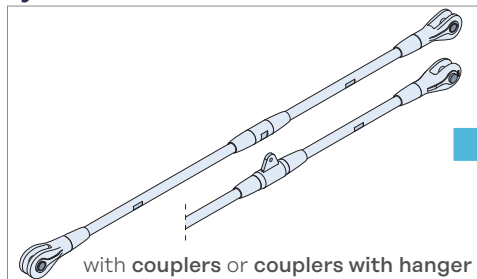

Ordering example → page 11
 Load capacity, system dimensions and materials:
 Steel → pages 16–17
 Stainless steel → pages 18–19

Cross bracing

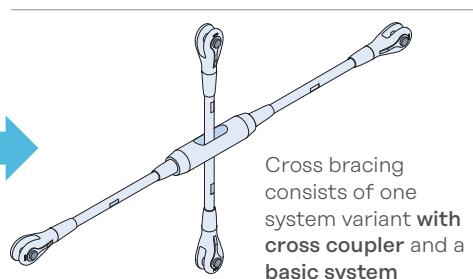
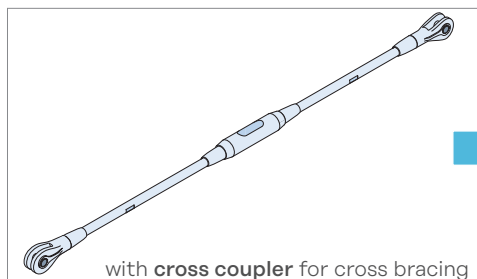

Ordering example → page 12
 Load capacity, system dimensions and materials:
 Steel → pages 16–17
 Stainless steel → pages 18–19

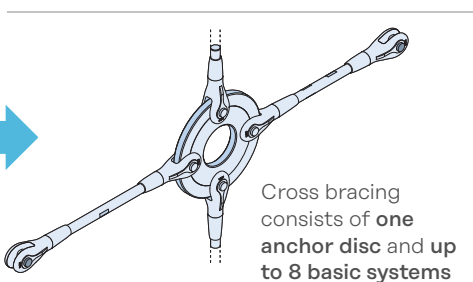
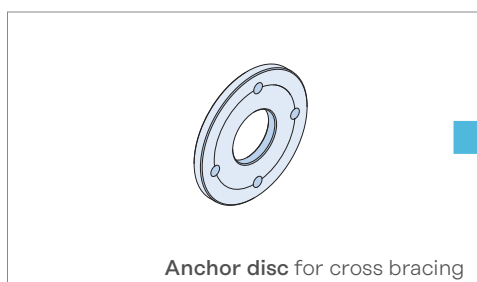

Ordering example → page 14
 Load capacity, system dimensions and materials:
 Steel → pages 16–17
 Stainless steel → pages 18–19

Halfen Detan Compression rod system

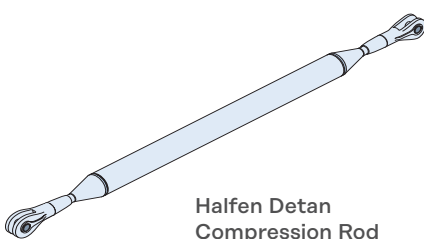

Ordering example → page 21
 Load capacity, system dimensions and materials → pages 18–19

Pretension unit



More information → pages 27–28

Halfen Detan Rod systems

Product Range Overview: Halfen Detan Tension Rod System

Ordering procedure

Example order: **Tension rod system, Halfen Detan-S, $d_s = 30\text{ mm}$, $L = 4500\text{ mm FV}$, 1 coupler**

①

②

③

④

⑤

- ① Product
- ② System Halfen Detan
- ③ System $\varnothing d_s$
- ④ System length L
- ⑤ Specification

Basic system

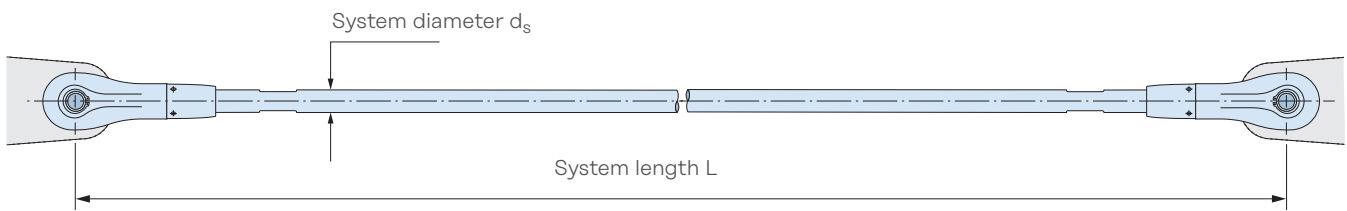

Ordering example (material steel HDG): Tension rod system, Halfen Detan-S, $d_s = 52\text{ mm}$, $L = 3620\text{ mm FV}$

System variants

with coupler:

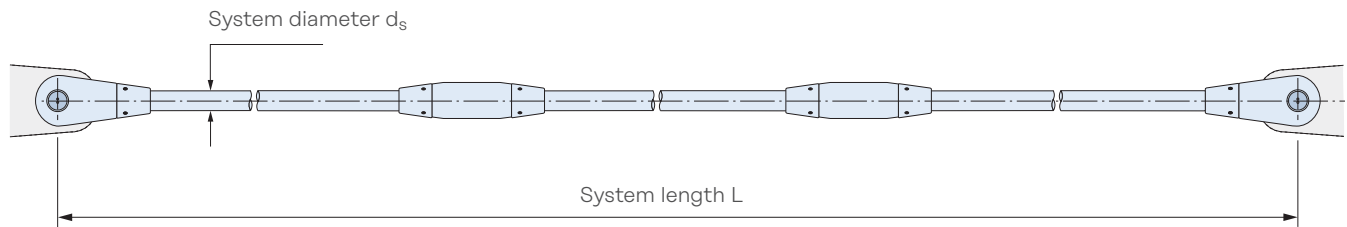

Ordering example (stainless steel): Tension rod system, Halfen Detan-D, $d_s = 24\text{ mm}$, $L = 11200\text{ mm}$, 2 couplers

Note: Maximum 5 couplers are possible.

Coupler with hanger

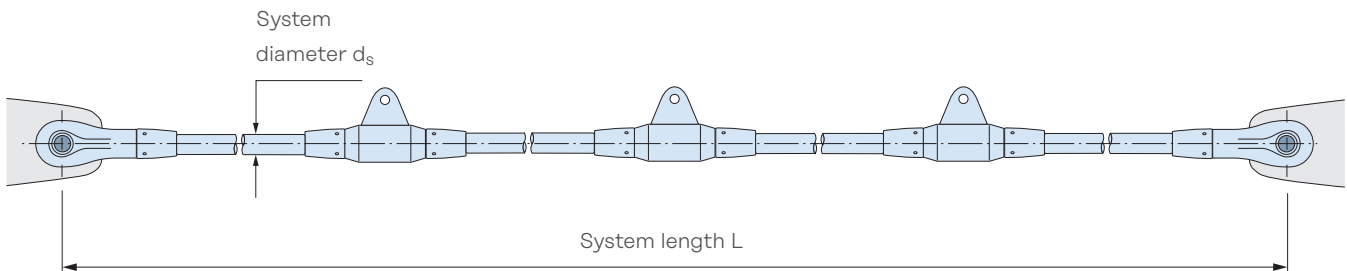

Ordering example (material steel HDG): Tension rod system, Halfen Detan-S, $d_s = 30\text{ mm}$, $L = 34000\text{ mm FV}$, 3 couplers with hanger

Halfen Detan Rod systems

Product Range Overview: Halfen Detan Tension Rod System

System Detan-S, European Technical Assessment ETA-05/0207														
System - Ø d _s [mm]	10	12	16	20	24	27	30	36	42	48	52	56	60	76
Available minimum system length L [mm]														
Rod hot-dip galvanized	250	310	360	440	520	560	600	700	810	940	990	1050	1160	1480
Available maximum system length L with one rod [mm]														
Rod hot-dip galvanized	6060	6070	11930	11950	11970	11990	11990	12020	12070	12110	12120	12140	12170	15430

System Detan-D, European Technical Assessment ETA-23/0276									
System - Ø d _s [mm]	8	10	12	16	20	24	30	36	42
Available maximum system length L with one rod [mm]									
Polished	6030	6040	6050	6060	6070	6090	6110	6130	6160

System variants

Cross coupler for cross bracing:

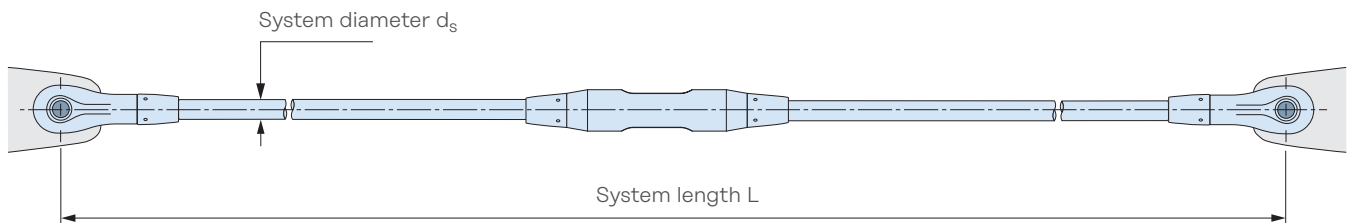

Ordering example (material steel HDG): Tension rod system, Halfen Detan-S, $d_s = 30$ mm, $L = 5600$ mm FV, 1 cross coupler

System dimensions Detan-S [mm]														
System - Ø d _s	10	12	16	20	24	27	30	36	42	48	52	56	60	76
Reduction for 2 × fork	60	73	85	107	128	140	148	179	220	264	277	290	324	432
O _m	15.0	18.5	22.5	27.0	34.0	37.5	42.5	51.0	55.0	62.5	70.5	77.5	85.0	115.0
L _{km}	100	120	142	166	200	222	242	284	310	348	400	440	478	631
min. system length	550	650	750	900	1050	1150	1200	1400	1600	1850	2000	2100	2300	2950

Thread depth O_m and Coupler length L_{km} also see page 16-17

Halfen Detan Rod systems

Product Range Overview: Halfen Detan Tension Rod System

Minimal system length

min. system length = 1 × cross coupler, 2 × tension rods, 2 × forks and 4 × locking-nuts

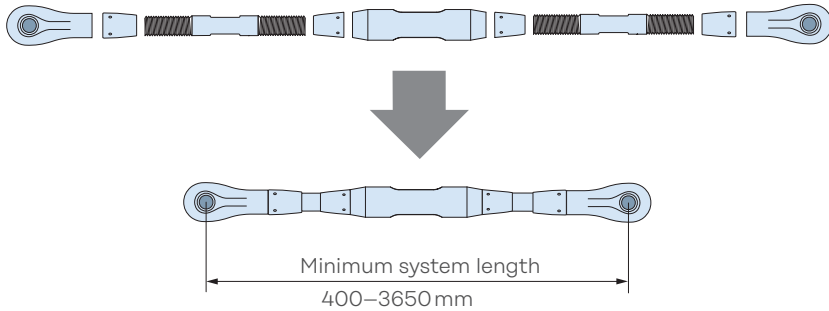

Spanner flats are available with bars from ≥ 900 mm in length

System variant with asymmetric distribution of couplers



Order with specification of system length L:

We calculate the rod lengths and minimum and maximum system length. The couplers are distributed symmetrically. If an asymmetric distribution of the couplers is required, a drawing with all necessary measurements must be included.

We will detail **complex rod systems** as one configured system. A **drawing** with system dimensions is sufficient.

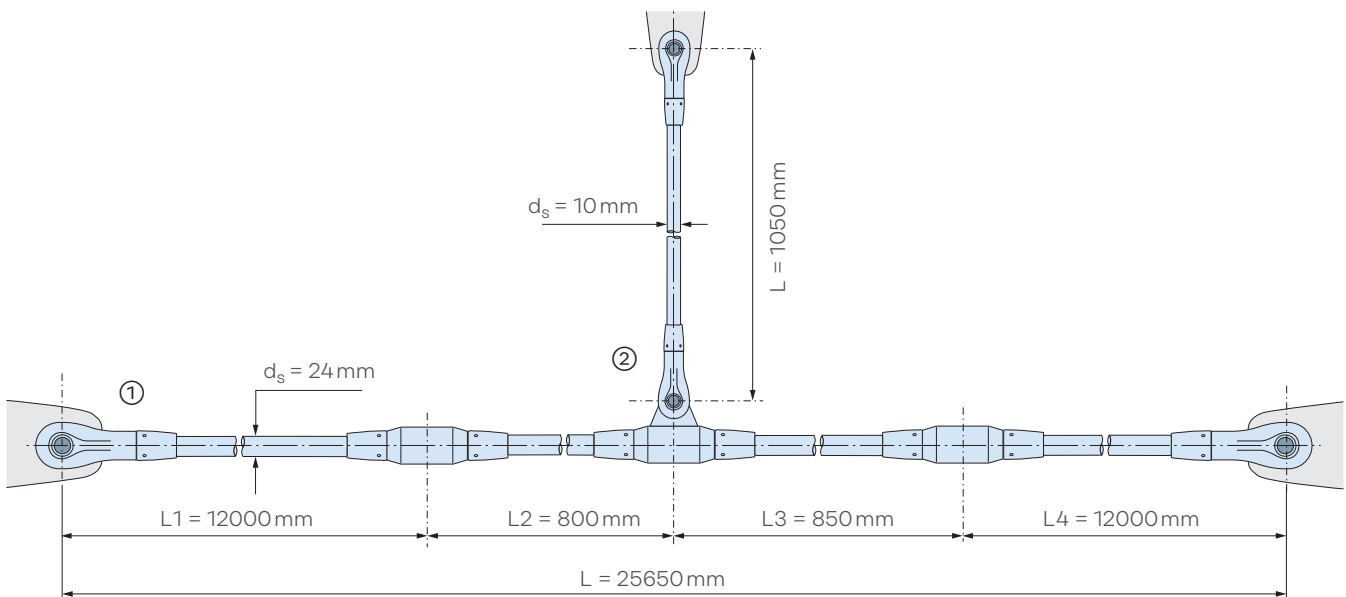

Ordering example:

- ① Tension Rod System, Halfen Detan-S, $d_s = 24$ mm, system length according to drawing, WB, couplers according to drawing
- ② Tension Rod System, Halfen Detan-S, $d_s = 10$ mm, system length $L = 1050$ mm, WB

Halfen Detan Rod systems

Product Range Overview: Cross bracings

Cross bracings

Anchor disc

Note:

- maximum 8 tension rod connections are possible
- connecting angle $\alpha_{\min} = 40^\circ$

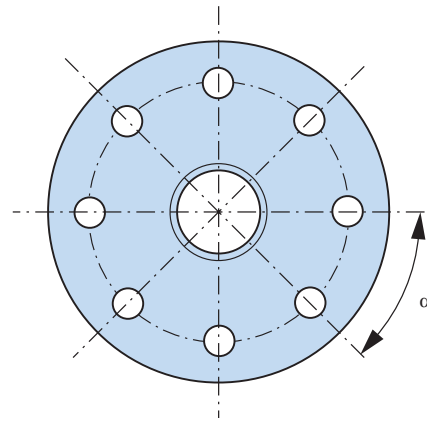
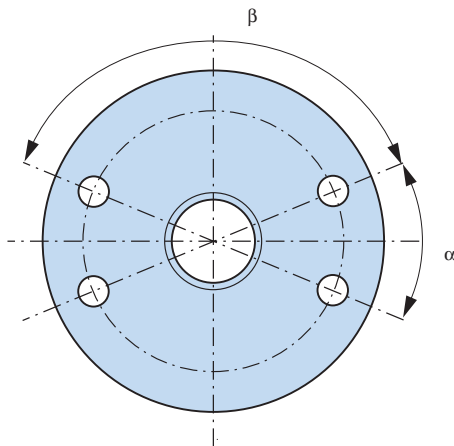

1. **Ordering example:** Anchor disc, Halfen Detan-S, $d_s = 42$ mm, 4 holes drilled $\alpha = 40^\circ$, $\beta = 140^\circ$ (see drawing), FV

2. **Ordering example (stainless steel):** Anchor disc, Halfen Detan-D, $d_s = 24$ mm, 8 holes drilled $\alpha = 45^\circ$ (see drawing)

System Detan-S, European Technical Assessment ETA-05/0207														
System - $\varnothing d_s$ [mm]	10	12	16	20	24	27	30	36	42	48	52	56	60	76

System Detan-D, European Technical Assessment ETA-23/0276									
System - $\varnothing d_s$ [mm]	8	10	12	16	20	24	30	36	42



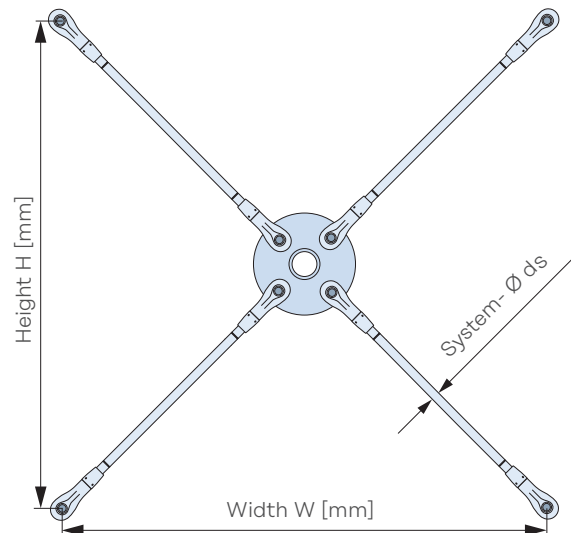
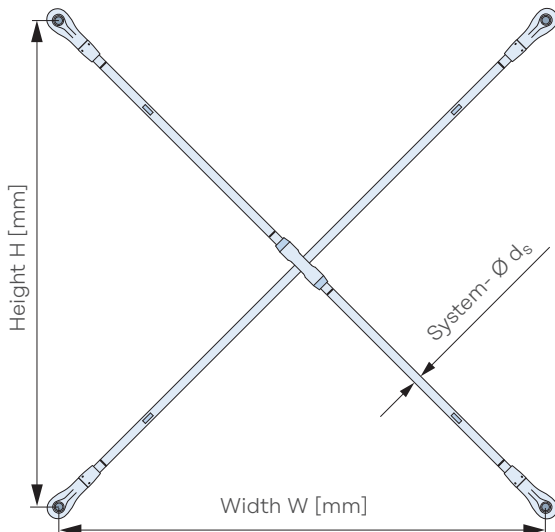



















Alternatively, please enquiries for **complete systems** with bracings as cross couplers or as anchor disks.
A drawing with system dimensions is sufficient.

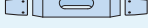

Halfen Detan Rod systems

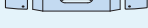
Product Range Overview: Set articles and individual components

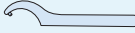
Set articles and individual components

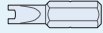
	■ Tension rod (specify rod length separately)		■ Pin
	■ Fork connection set: Fork, locking-nuts, pins, circlips ①, sealing kit ①, left-hand thread		■ Locking nut, left-hand thread
	■ Fork connection set: Fork, locking-nuts, pins, circlips ①, sealing kit ①, right-hand thread		■ Locking nut, right-hand thread
	■ Fork connection set: Fork, locking-nuts, pins, circlips ①, sealing kit ①, right-hand thread		■ Flat seal ①
	■ Fork connection set: Fork, locking-nuts, pins, circlips ①, sealing kit ①, right-hand thread		■ Round seal ①
	■ Coupler set: coupler + 2 locking-nuts, sealing kit ①		■ Circlip for one fork ①
	■ Coupler set with hanger: coupler with hanger + 2 locking-nuts, sealing kit ①		■ Coupler, with hanger
	■ Coupler set with hanger: coupler with hanger + 2 locking-nuts, sealing kit ①		■ Coupler, without hanger
	■ Cross coupler set: cross coupler + 2 locking-nuts, sealing kit ①		■ Fork, left-hand thread
	■ Cross coupler set: cross coupler + 2 locking-nuts, sealing kit ①		■ Fork, right-hand thread
	■ Spanner		■ Cross coupler
	■ Snake-eye tool		

① Stainless steel variant is without sealing kit/circlip.

European Technical Assessment is only valid when using components as a complete system

1. Ordering example: Connection set, Detan-S, $d_s = 20$ mm, left-hand thread, FV

2. Ordering example: Tension rod, Halfen Detan-S, $d_s = 10$ mm, L = 500 mm, thread length left = 120 mm, thread length right = 150 mm

DT-S Hook spanners for Detan-S	
Order number	Use soft touch pliers for Detan-S diameter M10 and M12
3000021769	Hook spanner for locking nut M16
3000021770	Hook spanner for locking nut M20
3000021771	Hook spanner for locking nut M24
3000021772	Hook spanner for locking nut M27
3000021773	Hook spanner for locking nut M30
3000021774	Hook spanner for locking nut M36
3000021775	Hook spanner for locking nut M42
3000021776	Hook spanner for locking nut M48
3000021777	Hook spanner for locking nut M52-M60
3000021778	Hook spanner for locking nut M76

DT-D Hook spanners for Detan-D	
Order number	Use soft touch pliers for Detan-D diameter M8, M10 and M12
3000027437	Hook spanner for locking nut M16
3000027438	Hook spanner for locking nut M20
3000027439	Hook spanner for locking nut M24
3000027440	Hook spanner for locking nut M30/M36
3000027441	Hook spanner for locking nut M42
DT-D 97 Snake Eye/Bit for Detan-D	
3000025324	Snake-eye/Bit 4 M8-M12
3000025325	Snake-eye/Bit 6 M16-M20
3000025326	Snake-eye/Bit 10 M24-M42

Halfen Detan Rod systems

Tension Rod System Halfen Detan-S,
European Technical Assessment ETA-05/0207

System components — materials and finish															
		Tension rod			Fork			Couplers, locking-nuts				Anchor disc			
System - Ø d _s [mm]		10 - 12		16 - 76		10 - 12		16 - 76		10 - 76				10 - 76	
Material		S355J2		S520		S355J2		G20 Mn5+QT		S355J2/S235JR				S355J2	
Finish	FV	hot-dip galvanized			hot-dip galvanized			hot-dip galvanized				hot-dip galvanized			
	WB	mill finish			hot-dip galvanized			hot-dip galvanized				hot-dip galvanized			

System load capacities; system- and available rod lengths; material specification, steel strength grade S355 (diameter d _s 10-12) or S520														
System - Ø d _s [mm]	10	12	16	20	24	27	30	36	42	48	52	56	60	76
System load capacities														
Load capacity Ft,R,d [kN]	21.3	30.94	81.22	126.9	182.7	238.1	290.6	423.4	581.1	763.7	911.3	1052.4	1224.5	2016.2
Available minimum system length L [mm]														
mill finish, hot-dip galvanized	250	310	360	440	520	560	600	700	810	940	990	1050	1160	1480
Available maximum system length with one rod [mm]														
mill finish, hot-dip galvanized	6060	6070	11930	11950	11970	11990	11990	12020	12070	12110	12120	12140	12170	15430
Available maximum rod length L [mm]														
mill finish, hot-dip galvanized	6000			11850								15000		

In accordance with ETA-05/0207 the partial safety value for the table above are assumed as $\gamma_{M0} = 1.0$ and $\gamma_{M2} = 1.25$
Design load $F_{t,R,d}$ according to annex B11 of ETA-05/0207. The load capacities in this table were determined on the basis of different available material strengths.

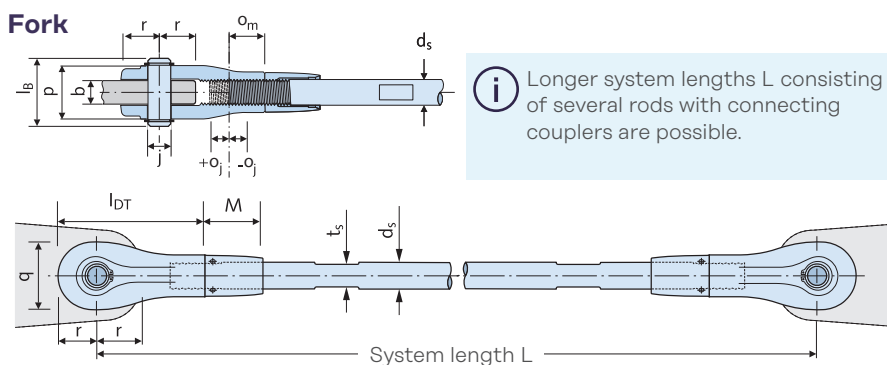

System dimensions [mm], materials — see table above															
System - Ø	d _s	10	12	16	20	24	27	30	36	42	48	52	56	60	76 ①
Fork length	L _{DT}	60	73	89	110	133	147	160	192	225	265	285	305	335	460
Pin length	l _B	28	32	44	52	60	65	72	84	97	111	119	130	139	180
Fork width	p	20	24	33	40	46	51	57	68	79	90	98	107	116	146
Fork height	q	26	31	41	51	61	69	75	90	105	119	125	137	146	196
Thread depth	o _m	15.0	18.5	22.5	27.0	34.0	37.5	42.5	51.0	55.0	62.5	70.5	77.5	85.0	115
Screw adjustment range	o _j	5.0	6.5	7.5	8.0	11.0	12.5	12.5	14.0	15.0	17.5	20.0	22.5	25.0	39
Length locking nut	M	24.5	37.0	41.0	50.0	58.0	63.0	64.0	72.0	83.0	91.0	98.0	105	112	148
Tension rod	Spanner width t _s													Hook spanner ②	
	8	10	14	18	21	24	27	32	36	41	46	50	55	60-90/6 ③	
Locking-nuts	Use soft touch pliers	With hook spanner													
		25-28	30-32	34-36	40-42	45-50	52-55	60-90/6 ③	68-75	80-90	80-90	80-90	95-155/6 ③		

① Delivery time on request.

② When using a chain tensioner instead of a hook spanner we recommend protecting the rod surface against damage (also applies to the couplers).

③ Adjustable hook-spanner

Corrosion protection: rod thread hot-dip galvanized. Fork threads sealed with stoppers. Also see page 24 for sealing system.

Halfen Detan Rod systems

Tension Rod System Halfen Detan-S
European Technical Assessment ETA-05/0207

Connecting plates

The load transfer from the rod system into the plates is considered as verified if the dimensions in the table have been observed. Plates are **not** included in the scope of delivery.

Note: **A** It may not always be possible for the fork end to be able to swing into place. In this case an additional anchor disk must be used. See page 23.

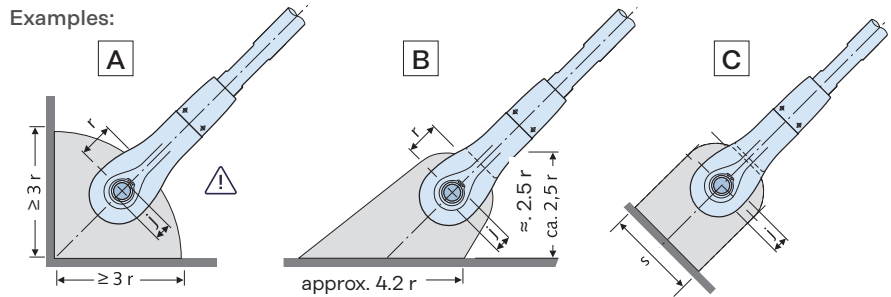

Dimensions [mm]; Material — minimum qualities for Ø 10-12, steel strength grade S235JR; or for Ø 16-95, steel strength grade S355J2

System - Ø	d _s	10	12	16	20	24	27	30	36	42	48	52	56	60	76
Thickness conn. plate	b	8	10	15	18	20	22	25	30	35	40	45	50	55	65
Hole diameter for pin	Ø j	9.5	11.5	15.5	19.5	23.5	26.5	29.5	33.5	41	47	49	53	57	76
Hole position	r	15	18	24	29	35	39	43	51	60	70	76	83	88	129
Minimum width	s	28	33	41	53	66	76	83	97	117	134	143	152	162	222

Cross bracing

Option 1:

Anchor disc standard K40
(smallest connecting angle
 $\alpha_{\min} = 40^\circ$)

Example: Anchor disc
with 4 tension rods
(max. of 8 rod
connections per disc)

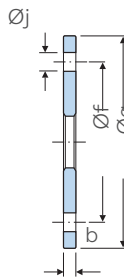
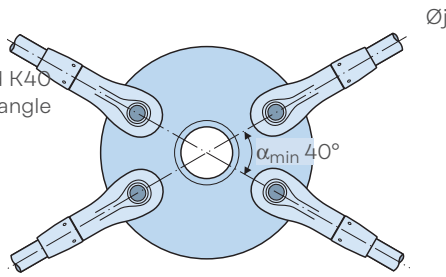

Option 2:

Cross coupler

(connecting angle
 $\alpha = 40^\circ - 90^\circ$)

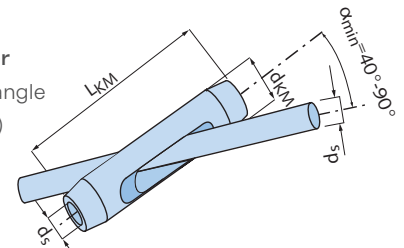

Anchor disc — Dimensions [mm]; material specification, steel strength grade S355J2, hot-dip galvanized

System - Ø	d _s	10	12	16	20	24	27	30	36	42	48	52	56	60	76
Diameter of outer holes	Ø f	90	110	140	180	210	240	260	310	360	420	450	490	520	702
Outer anchor disc - Ø	g	120	146	186	238	280	318	346	412	480	558	600	652	692	960

Cross coupler — Dimensions [mm]; material specification, steel strength grade S355J2, hot-dip galvanized

System - Ø	d _s	10	12	16	20	24	27	30	36	42	48	52	56	60	76
Coupler length	L _{KM}	100	120	142	166	200	222	242	284	310	348	400	440	478	631
Coupler diameter	d _{KM}	20	24	32	39	46	52	57	70	80	93	101	112	120	154

Couplers

Note: Coupler with hanger only for system diameter 12mm and higher.

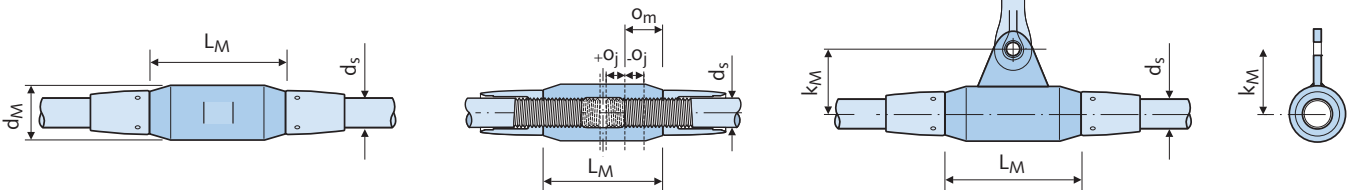

Dimensions [mm]; material specification, steel strength grade S355J2, hot-dip galvanized

System - Ø	d _s	10	12	16	20	24	27	30	36	42	48	52	56	60	76
Coupler length	L _M	40	50	62	78	94	104	120	140	158	180	195	210	245	328
Coupler diameter	d _M	20	22	28	35	42	47	53	64	75	87	93	98	104	155
Thread depth	o _m	15.0	18.5	22.5	27.0	34.0	37.5	42.5	51.0	55.0	62.5	70.5	77.5	85.0	115
Screw adjustment range	o _j	5.0	6.5	7.5	8.0	11.0	12.5	12.5	14.0	15.0	17.5	20.0	22.5	25.0	39
Suspension system diam.	d _{sa}	-	10	10	10	10	10	10	10	10	12	12	12	12	12
Offset of suspension hole	k _m	-	28.0	31.0	44.5	48.0	50.5	57.5	72.0	86.5	98.5	111.5	124.5	137.0	140.0
Hook spanner size		-	-	-	-	-	-	-	-	-	-	-	-	-	155/8

Halfen Detan Rod systems

Tension Rod System Halfen Detan-D

European Technical Assessment ETA-23/0276

System components — material and design									
	Tension rod ^②	Fork ^③	Couplers ^{③ ④} , locking nuts ^③	Pins ^{②④} , circlips ^①	Anchor disc ^②				
System - Ø d _s [mm]	8 - 42	8 - 42	8 - 42	8 - 42	8 - 42				
Material	Stainless steel	Stainless steel	Stainless steel	Stainless steel	Stainless steel				
Finish	polished	polished	polished	polished	polished				
① circlips according to DIN 471, stainless steel 1.4568/1.4568			③ material stainless steel, strength grade S355						
② material stainless steel, strength grade S460			④ material stainless steel, strength grade S235						
Stainless steel acc. to ETA-23/0276, annex 2 corresponds to corrosion resistance class III									
Note: When using Halfen Detan-D the effects of corrosion for various ambient conditions must be verified by the design engineer for each separate case.									
Load capacities, system and available rod lengths, material; stainless steel									
System - Ø d _s [mm]	8	10	12	16	20	24	30	36	42
System load capacities									
Load capacity F _{t,R,d} [kN] ^⑥	17.1	27.1	39.4	73.3	114.6	165.0	262.4	382.2	524.6
Available maximum system length with <u>one</u> rod [mm] ^⑥									
Polished	6030	6040	6050	6060	6070	6090	6110	6130	6160
In accordance with ETA-23/0276 the partial safety value for the table above are assumed as γ _{M0} = 1.0 and γ _{M2} = 1.25 If other partial safety factors are to be applied the load capacities have to be calculated according to ETA-23/0276.									
⑥ F _{t,R,d} : Design tension resistance according to ETA-23/0276 annex B11.									
⑥ Longer system lengths L consisting of several rods with connecting couplers are possible!									

Fork

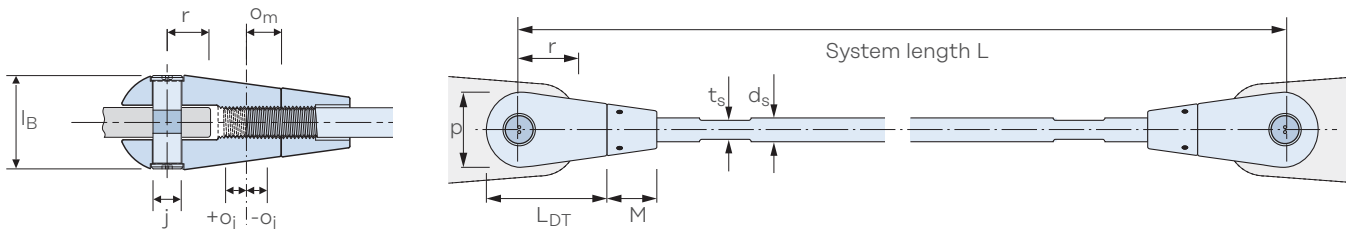

System dimensions [mm]; materials, see table above										
System - Ø	d _s	8	10	12	16	20	24	30	36	42
Fork length	L _{DT}	40	49	60	78	94	115	140	169	196
Pin length	l _B	23	28.5	34	46	58	68	86	103	118
Fork width	p	23.5	29	35	48	60	70	89	106	123
Fork height	q	23.5	29	35	48	60	70	89	106	123
Thread depth	o _m	12.5	15	18.5	23.5	28	35	42.5	50	57
Screw adjustment range	o _j	4.5	5	6.5	7.5	8	11	12.5	14	15
Length locking nut	M	18	22	27	33	38	49	60	71	84
Tension rod assembly: Spanner width	t _s	6	8	10	14	18	21	27	32	36
Locking nut assembly: Spanner/Snake-eye Bit		use soft touch pliers			30-32	34-36	45-50	68-75	68-75	80-90
		Snake-eye Bit 4			Snake-eye Bit 6		Snake-eye Bit 10			
Edge distance	r	→ see table on page 17 for dimensions of connecting plates								
Pin hole diameter	j									
Thickness of connection plate	b									

Halfen Detan Rod systems

Tension Rod System Halfen Detan-D
European Technical Assessment ETA-23/0276

Connecting plates

The load transfer from the rod system into the connection plates is considered as verified if the dimensions in the table have been observed. Connection plates are **not** included in the scope of delivery.

Note: **A** It may not always be possible for the fork end to be able to swing into place. In this case an additional anchor disk must be used. See page 23.

Examples:

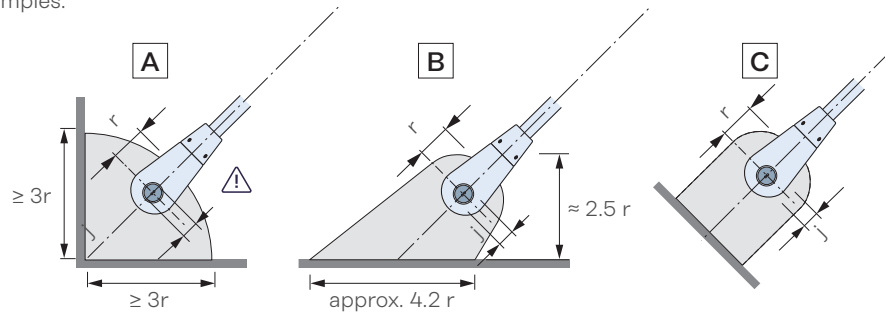

Dimensions [mm]; material — minimum qualities: Stainless steel, strength grade S235

System - Ø	d _s	8	10	12	16	20	24	30	36	42
Thickness conn. plate	b	8	10	12	15	20	20	30	30	35
Hole diameter for pin	Ø j	7.5	9.5	11.5	14.5	18.5	21.5	26.5	30.5	35.5
Hole position	r	12	15	18	23	29	35	43	54	63

Cross bracing

Option 1: **Anchor disc** standard K40 (smallest connecting angle α min = 40°) Example: Anchor disc with 4 tension rods (maximum 8 tension rod connections per disc)

Option 2: **Cross coupler** (connecting angle α = 40°-90°)

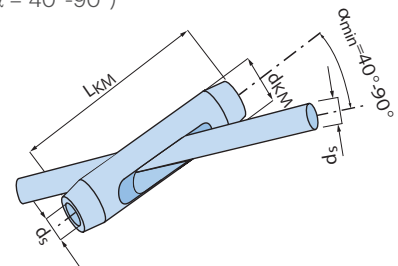
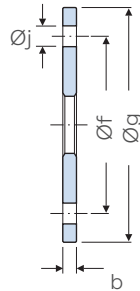
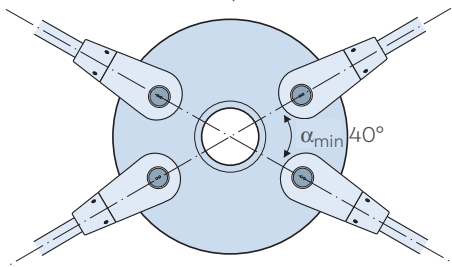

Anchor disc: Measurements [mm]; Material: Stainless steel, strength grade S460

System - Ø	d _s	8	10	12	16	20	24	30	36	42
Outer hole diameter	f	76	93	112	150	184	212	269	318	367
Outer anchor disc diameter	g	100	123	148	196	242	282	355	425.5	493.5

Cross coupler: Measurements [mm]; Material: Stainless steel, strength grade S355/S235

System Ø	d _s	8	10	12	16	20	24	30	36	42
Coupler length L	K _M	90	110	126	155	180	210	262	320	380
Coupler diameter	d _{KM}	20	25	28	38	48	58	70	82	96

Couplers

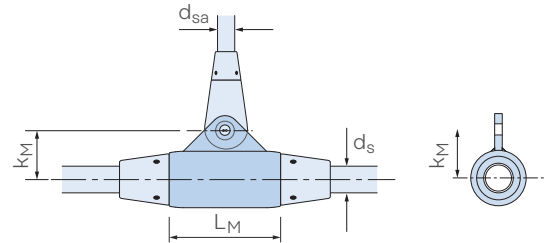
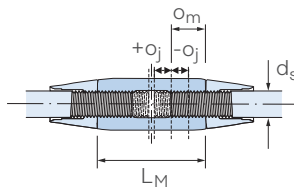
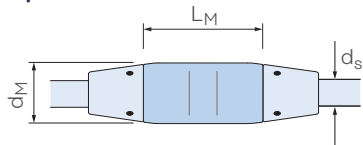

Cross coupler with hanger from system diameter 12

Dimensions [mm]; Material, stainless steel, strength grade S355/S235

System - Ø	d _s	8	10	12	16	20	24	30	36	42	
Coupler length	L _M	38	45	56	83	82	104	125	144.5	166.5	
Coupler diameter	d _M	17	21	25	35	43	52	65	78	90	
Thread depth	Ø _m	12.5	15	18.5	23.5	28	35	42.5	50	57	
Suspension system diam.	d _{sa}	-	-	8				10			
Offset, suspension hole	k _M	-	-	28	33	37	49	59.1	74.5	93.1	

Halfen Detan Rod systems

Couplers and Compression Rods

Cross couplers

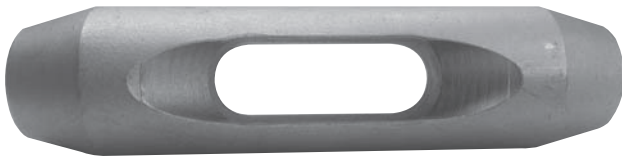

Cross coupler with a minimal cross angle of 40°

The Halfen Detan Cross coupler is an alternative to the anchor disc cross coupler. The new cross coupler can be used for minimum crossing angles. The cross coupler can be used instead of the anchor disc and 4 fork heads. In both cases the same load capacity is guaranteed.



Cross-bracing with a cross coupler

The cross couplers are elegant solutions and allow contactless crossing of tension rods in the same plane.

Other advantages are the moderate costs compared to an anchor disc solution and the easy installation.

Compression rods



Bracing between an exterior steel column and an interior steel beam

The Halfen Detan Rod system is an intelligent system combining tension and compression rods. To complement the Halfen Detan Rod system we also supply compression rods that integrate perfect both visually and technically into the system. To blend in and to match the tension rods the compression rods taper towards the rod-ends. This allows use of the same design of fork and locking-nuts to give a uniform design. The concept is especially convincing as the forks are suitable for compression as well as for tension loads. This combination of tension and compression rods is therefore technically very beneficial.

In addition to standard pipe profiles we also provide other pipe cross-sections and special solutions.

The compression rod systems are pre-assembled with our standard forks and locking-nuts.



Compression system connected to a welded plate

Halfen Detan Rod systems

Product Range Overview: Halfen Detan Compression Rod System

Compression rod

To complement the tension rod system we also offer compression rods, which can be incorporated technically and aesthetically perfect into a system. Compression rods consist of

larger diameter tubes, which are tapered at each end allowing **standard Halfen Detan Fork heads to be used.**

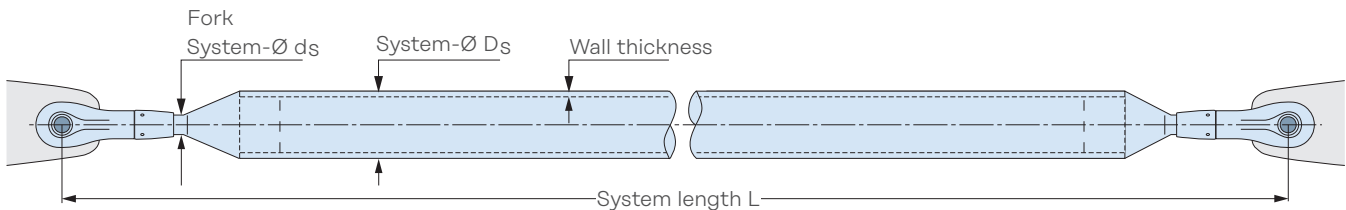

Ordering example: Compression rod system, Halfen Detan-S, $D_s = 42\text{ mm}$, $L = 2000\text{ mm}$, fork connector $d_s = 16\text{ mm}$

Ordering example (stainless steel): Compression rod system, Halfen Detan-D, $D_s = 60\text{ mm}$, $L = 3200\text{ mm}$, fork connector $d_s = 24\text{ mm}$

Rod cross-sections — examples / recommended configurations							
System - Ø D_s [mm]	42	54	60	76	89	114	139
Wall thickness [mm]	2.6	2.6	2.9	2.9	3.2	3.6	4.0

Other rod dimensions are also available. Please contact us for further information.



Static calculation of compression rods is required for individual projects. A free Halfen Detan Calculation program is available. Contact us if you require assistance. An enquiry with drawings, system dimensions and static verification is also possible.

All fork and connecting plate system dimensions; see page 16–17 (steel) → page 18–19 (stainless steel)

Compression rod in steel			
System - Ø D_s [mm]	Compression rod	Fork	Locking nut
	42-139/according to statics calculations	according to statics calculations	see fork
Material	S355J2	G20 Mn5+QT	S235JR
Finish	FV	hot-dip galvanized	hot-dip galvanized
	WB	mill finish	hot-dip galvanized

Compression rod in stainless steel			
System - Ø D_s [mm]	Compression rod	Fork	Locking nut
	42-139/according to statics calculations	according to statics calculations	see fork
Material	S235	S460	S235
Finish	stainless steel ①	stainless steel ①	stainless steel ①

① Stainless steel corresponds to corrosion protection class III as in DIN EN 1993-1-4



Note: The design engineer is responsible for verifying the corrosion resistance is suitable for the various ambient conditions for each individual case when using Halfen Detan-D.

System assembly

Length adjustment at the forks.

The cone (with thread) is inserted in the rod and secured with a continuous weld.

Available as a custom piece with at least one fork.

The cone cannot be ordered as a single component, delivery only as a complete pressure rod.

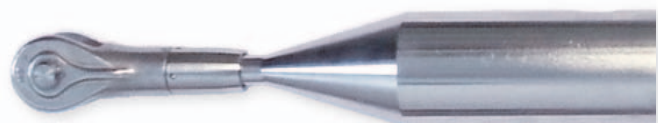

Halfen Detan Rod systems

Halfen Detan surface finishes and coatings, fire protection

Halfen Detan-D surface finishes

Surface finish is usually an important factor in applications using stainless steel.

Stainless steel rods are bright drawn as standard but can be satin or hand polished if required.

Forks and lockings nuts can be electro-polished, satin-polished or hand polished when required. Couplers and anchor discs are supplied with a smooth machined finish as standard, and can be satin-polished or hand polished when required.



Material and surface finishes					
Material	Bar	Fork, nut	Coupler	Cross Coupler	Disc
Electro-polished (EP)	Bright drawn	Electro-polished	Machined	Electro-polished	Machined
Satin-polished (SP)	Bright drawn	Satin-polished	Satin-polished	Satin-polished	Satin-polished
Hand polished (HP)	Hand polished	Hand polished	Hand polished	Hand polished	Hand polished

Duplex-coatings

Custom colour design: Powder coating

Two criteria can be met with a protective powder coating: Free architectural design using colour with simultaneous improvement of the corrosion protection. The coatings can be applied by a certified coating specialist.

Duplex-coating (Hot-dip galvanized + paint coating or powder coating) according to EN ISO 12944-5.



Fire protection

There are reactive fire protection systems for steel elements with round profiles approved by the German Institute of Construction Engineering (DIBt, Deutsches Institut für Bautechnik) on the market. We can gladly put you in touch with the supplier of such systems.

Downloads and information about the fire protection system HENSOTHERM® 421 KS by Rudolf Hensel GmbH, are available on the website at www.rudolf-hensel.de/421KS.



BRANDSCHUTZSYSTEME

Halfen Detan Rod systems

Connection plates and Installation

Examples — Connection plates and anchor discs

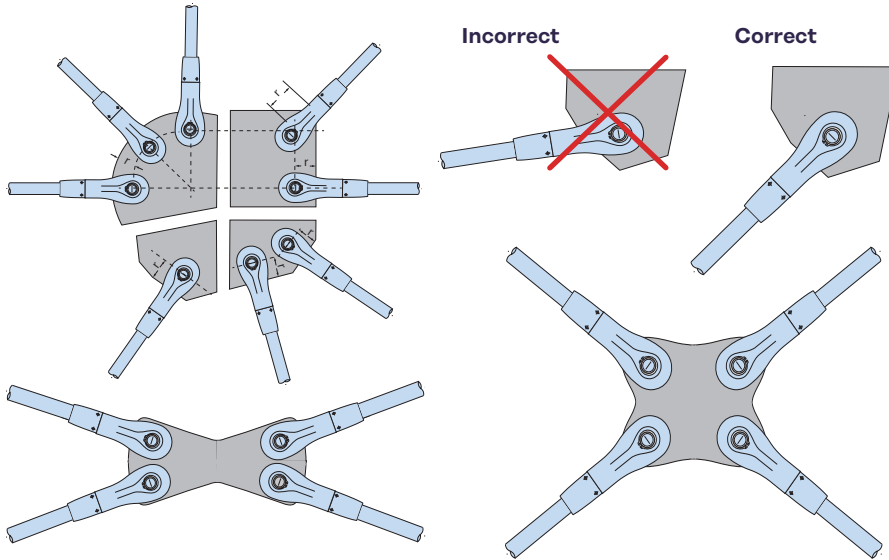

The connecting elements shown here are only examples of our custom solutions illustrating possible shapes of connecting plates. These steel plates are not standard products. Drawings are always required for enquiries and estimates.

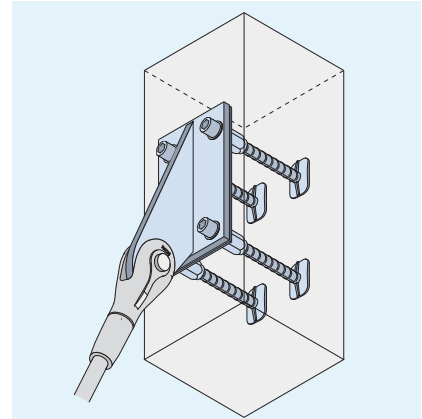

Halfen HUC Universal connection

A Technical Product Information pdf document can be downloaded here: www.halfen.com/products/reinforcement-systems/HUC-Universal-connection

Installation and safety notes

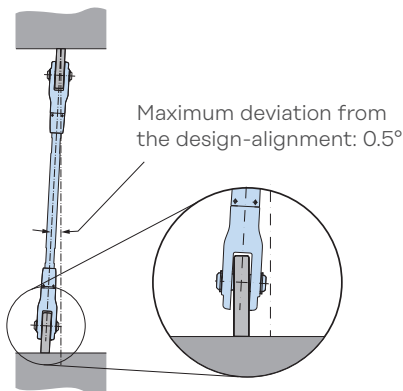

Figure 1

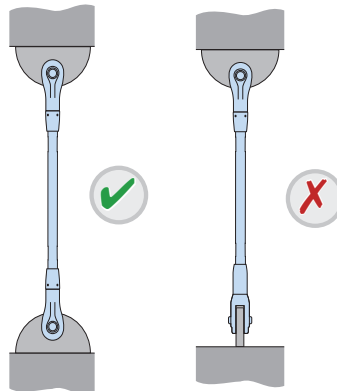

Figure 2a

Figure 2b

Forks must be **correctly aligned and positioned in the same plane** (Figure 1 and 2a) to ensure that the tension system is not subjected to bending.

To ensure the rod can be installed, one fork end of the rod must be able to swing into place; this may not always be possible (see figure 3b). **An anchor disk must be used** in this case, to allow correct installation (see figure 3a).

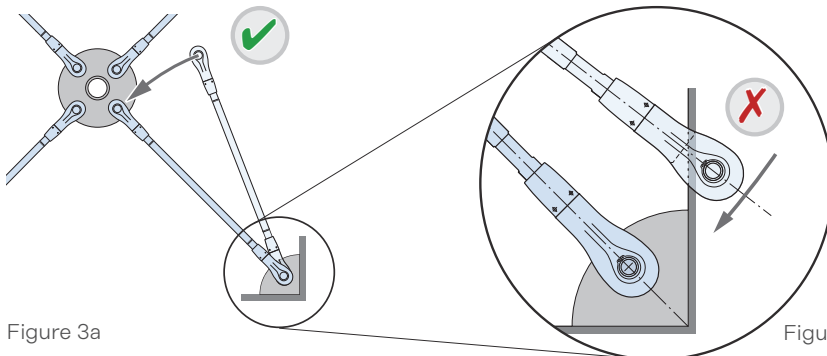

Figure 3a

Figure 3b

i More information can be found in the **installation instruction INST_DT** www.halfen.com/products/tension-rod-systems/detan-rod-system/product-information

For an **installation video** go to, www.halfen.com/service/videos/tension-rod-systems



Prior to installation all Halfen Detan Rod system components must be checked for damage. Damaged components must not be used.

Halfen Detan Rod systems

Corrosion protection

Corrosion protection Halfen Detan-S

The Halfen Detan Rod systems offer high protection against corrosion, especially for vulnerable parts of the system, e.g. the threads.

The forks and locking-nuts are hot-dip galvanized to ensure durable top-quality protection against corrosion as well as to ensure good mechanical resistance.

Reliable and durable

- tension rods are completely hot-dip galvanized after production
- no danger of hydrogen embrittlement
- no flaking zinc
- large spanner flats ensure that rod can be properly tightened
- forks and locking-nuts are hot-dip galvanized
- threads are corrosion protected
- threads are additionally protected against humidity and contamination

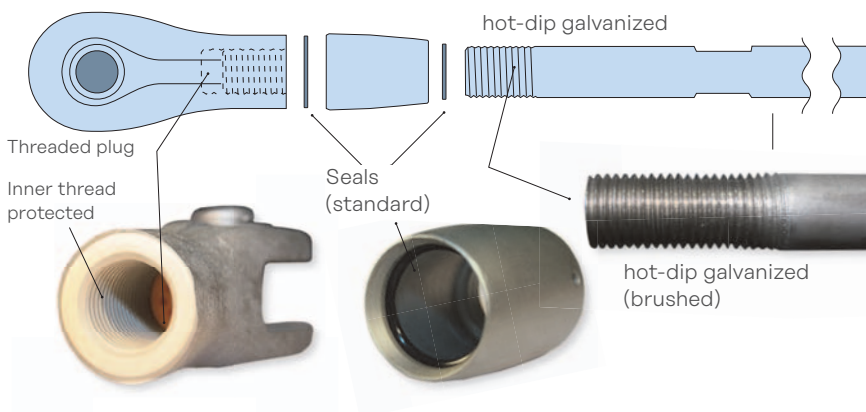

Sealing systems for system-component (for tension and compressure rods) = effective protection against humidity and contamination

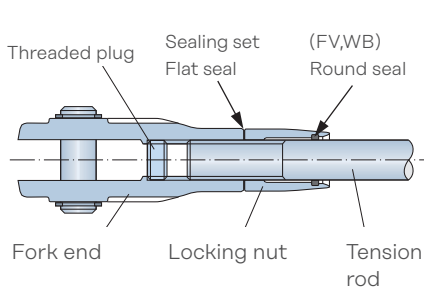

All forks are delivered with a threaded cap inserted to protect the thread as standard. The caps are colour-coded to help identify the thread direction:

- Yellow** = right-hand thread,
- Blue** = left-hand thread.

A special sealing system is provided as standard for additional protection for all rod diameters larger 16 mm. We recommend sealing the outer joint of the locking-nuts on-site with a durable elastic silicone suitable for outdoor application. In general, all connecting couplers smaller than M16 should always be sealed using suitable silicone sealant.

Corrosion protection Halfen Detan-D

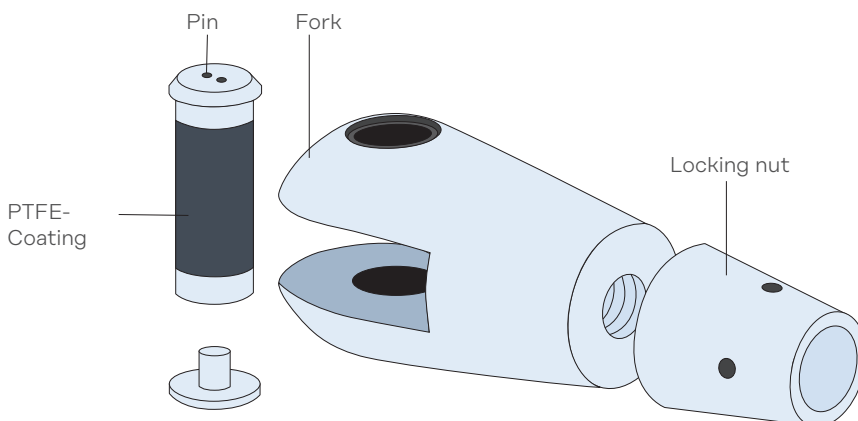

Each stainless steel fork is supplied with two clear, self-adhesive, PET (polyester) washers to isolate the system from a connecting plate of a dissimilar metal. Stainless steel pins are supplied with a PTFE coating around the barrel, as illustrated, to isolate the system from a connecting plate of a dissimilar metal.

Halfen Detan Rod systems

On-site logistics/Pre-assembly/Design Software

Optimal on-site logistics



Rod marked with system information

Avoid mix-ups on-site with system specific rod marking

- all rods are clearly marked with contract and customer specific data (order and rod position number, rod length, system size)
- standard for systems diameter 16 – 60mm (Halfen Detan-D)



Label with product-specific data

Easy and customer-friendly labels with specific information

- includes product-specific information, e.g. system length, system diameter
- exact identification and sorting with item position numbers
- optimized and efficient on-site logistics
- customer specified information possible: Project-data, e.g. floor numbers or node position

Certified quality

Pre-assembled delivery

The rod systems up to and including 60mm diameter will be delivered pre-assembled. (76mm diameter rods and larger are delivered in separate components).

Larger system elements will be separated at the couplers as required to enable delivery.

Economic and time saving

- no further on-site assembly required
- no danger of mix-ups
- pre-assembled to system length $L + o_j$, → see pages 16 and 18
- free movement of threads ensured
- easy online forms available for tender request, or use the order forms attached → see pages 30–35



Halfen Detan Design software

The Halfen Detan design software

Structural calculation and planning tool in one programme.

- structural calculation: tension rod system design according to ETA Assessment, compression rod system design according to EC3 and ETA Assessment
- various material options and finishes
- dimension results are used to generate item lists with individual positions listed in a print-out

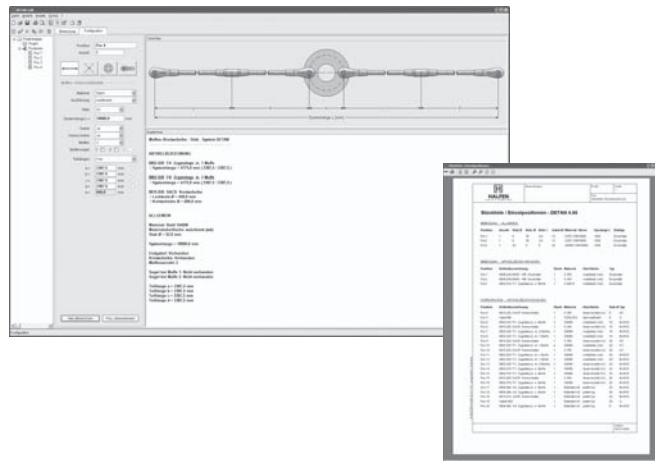

www.halfen.com/Downloads/Software-CAD/Dimensioning Software/Detan

Halfen Detan Rod systems

European Technical Assessment

ETA-European Technical Assessment – a secure basis for structural design



Halfen Detan-S

- European Technical Assessment ETA-05/0207
- CE marking

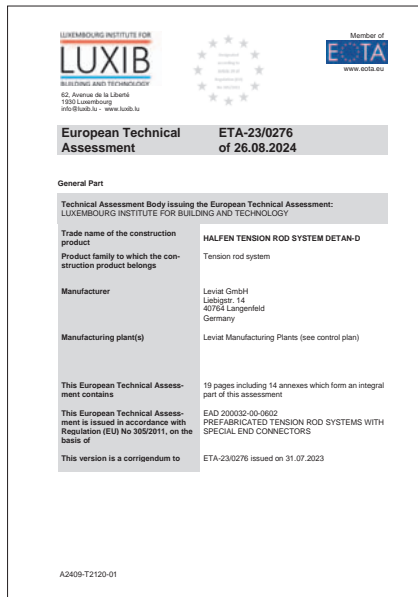

Halfen Detan-D

- European Technical Assessment ETA-23/0276
- CE marking



Halfen Detan approvals available on the internet:
[www.halfen.com/Products/Tension rod system/Detan Rod System /Product information](http://www.halfen.com/Products/Tension_rod_system/Detan_Rod_System/Product_information)

Assessment for Halfen Detan-S

- tension rod system Halfen Detan-S with European Technical Assessment ETA-05/0207
- up to 15% higher load capacities with the additional S470 and S520 strength classes which are included in the new ETA; compared with strength class S460
- CE marking recognized in all European Union countries
- design of allowable loads considering country-specific coefficients γ_{M0} and γ_{M2} (NA) using the Halfen Detan software
- EU wide standardised design concept
- no national approvals or certificates required
- cross couplers are a cost effective alternative to anchor discs for cross bracing

Design of compression rods

- compression rods are regulated in the ETA
- dimensioning of Halfen Detan-S compression rods from tube material, strength class S355 according to Eurocode 3 (EN1993-1-1)

Assessment for Halfen Detan-D

- tension rod system Halfen Detan-D in stainless steel with European Technical Assessment ETA-23/0276
- 25% higher loads compared to strength class S355 due to the higher tensile strength of the tension rods
- permanent quality and production monitoring by a supervisory institution
- CE marking recognized in all European Union countries
- design of allowable loads considering country-specific coefficients γ_{M0} and γ_{M2} (NA) using the Halfen Detan software
- EU wide, standardised design concept
- no national approvals or certificates required
- cross couplers are a cost effective alternative to anchor discs for cross bracings

Design of compression rods

- compression rods are regulated in the ETA
- dimensioning of Halfen Detan-D compression rods in stainless steel strength class 235, according to Eurocode 3 (EN1993-1-4)

Halfen Detan Rod systems

Halfen Detan Pretension Unit

Halfen Detan Pretension unit — Advantages and basics

The exact application of pretension for system diameters 30 and larger can be difficult, therefore additional tools such as hydraulic jacks become necessary.

The Pretension unit for use with Halfen Detan Rod systems from M30 to M60 provides an effective solution with load transfer using a threaded-plate preventing damages to the rod surface.

Additional advantages

- the system is optimised for Halfen Detan Rods
- extra lightweight aluminium design for simple assembly
- targeted hydraulic application for tension up to 425 kN
- no power-source needed
- the high-quality galvanized surface is protected by special load transfer plates
- simple control of load application with a calibrated manometer
- additional control using optional extensometer, even after load application (if previously gauge-marked)
- functional, simple & robust



Pretension check

If the rod was previously gauge-marked, the pretension force can be controlled using an extensometer.

This system can be used during, as well as after load application. This allows load control using hydraulic pressure as well as monitoring direct rod strain.

Similar to the Halfen Detan Pretension unit this device is easy to use, is robust and also requires no power-source.

Applying pretension

If pretensioning a system is intended then special couplers, special thread lengths and locking-nuts are required. These cannot be retrofitted and must therefore be taken into consideration at the planning stage.

Our technical support team is available to assist in any enquires. Contact information can be found at the back of this catalogue.

To apply pretension, special pretension units are available from our technical support team. The necessary rod force is converted into the required hydraulic pressure and then applied using the Halfen Detan Pretension unit.



Halfen Detan Rod systems

Halfen Detan Pretension Unit

Assembly of the pretension unit



Easy to attach and to operate

To avoid possible damage to the rod surface load transfer is via threaded plates. The hydraulic-system is attached in front and behind the coupler. The hydraulic jacks temporarily relieve the strain on the coupler, allowing the coupler to be easily turned by hand.

When reaching the desired pressure, the hydraulic unit is released and removed. After release the coupler takes the load. To ensure that the maximum recommended load has been reached the required hydraulic pressure is needed. Please refer to the table below.

Alternatively the load can be checked using an extensometer.

A detailed assembly instruction is available on the Internet:

[www.halfen.com/Service/Brochures/Installation instructions/Detan](http://www.halfen.com/Service/Brochures/Installation%20instructions/Detan)

System variations

with pretension coupler:

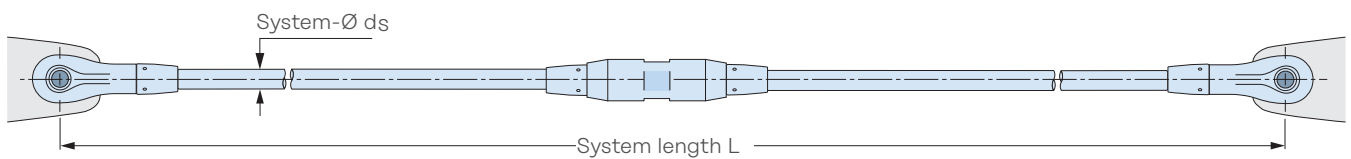

Ordering example (material steel): Tension rod system, Halfen Detan-S, $d_s = 30$ mm, $L = 5600$ mm FV, 1 pretension coupler

System load capacities, system lengths and available rod lengths							
System - Ø d_s [mm]	30	36	42	48	52	56	60
Cross-section A [mm ²]	707	1018	1385	1810	2124	2463	2827
Thread length o [mm]	105	118	126	139	176	188	195
Available min. system length with coupler L [mm]	1076	1244	1440	1652	1758	1866	2056
Load capacity $N_{R,d}$ [kN]	290.6	423.4	581.1	763.7	911.3	1052.4	1224.5

Pretension table for Detan Rod system S (some values are rounded)								
Max. recommended pretension ① [kN]	$N_{rec.}$	116	169	232	305	365	421	425 ②
Hydraulic pressure [bar]	p	190	277	380	500	596	688	695
Strain [%]	ϵ	0.78	0.79	0.80	0.80	0.82	0.81	0.72
Stress [N/mm ²]	σ	164	166	168	169	172	171	150
Elongation [μ m/10 cm]	$\Delta\lambda$	78	79	80	80	82	81	72

① Maximum recommended pretension without precise verification $\hat{=}$ 40% of $N_{R,d}$. ② Maximum hydraulic pressure at approx. 700 bar

Pretension coupler (all dimensions in [mm])								
System - Ø	d_s	30	36	42	48	52	56	60
Coupler length	L_M	120	140	158	180	195	210	245
Coupler - Ø	d_M	53	64	75	87	93	98	104
Locking nut length	M_v	99	107	118	126	158	165	172
Coupler assembly	SW	46	55	65	75	80	85	90
Tension rod assembly	Spanner width t_s							
		27	32	36	41	46	50	55
Locking nut assembly	Hook spanner size							
		45-50	52-55	68-75	68-75	80-90	80-90	80-90

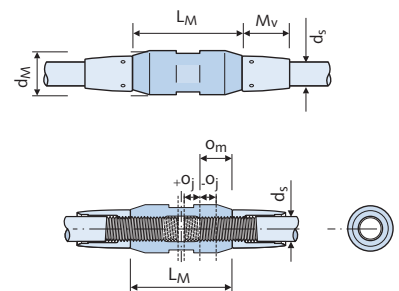

Halfen Detan Rod systems

Planning Help

Tender specification

Tension rod system Halfen Detan-S ...

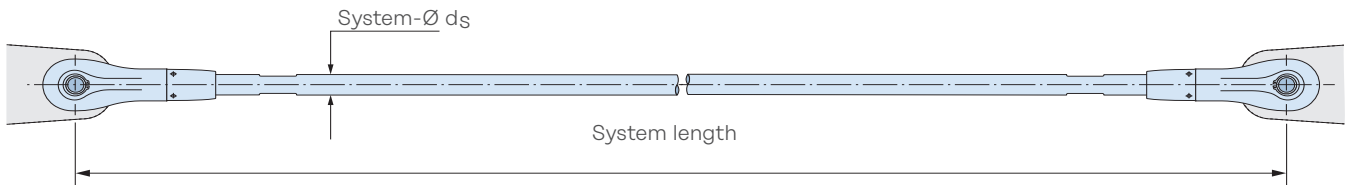

Tension rod system type Halfen Detan-S, consisting of 1 right-hand threaded fork, 1 left-hand threaded fork, plus 1 tension rod including 2 pins, 4 circlips and 2 DT-S nuts,

with European Technical Assessment ETA 05/0207, pre-assembled and product-specific-labelled tension rod system, type Halfen Detan-S $d_s = 30$, L, F

with

d_s = system-diameter [mm] (10 / 12 / 16 / 20 / 24 / 27 / 30 / 36 / 42 / 48 / 52 / 56 / 60 / 76)

L = system-length [mm] (from bolt-axis/to bolt-axis),

F = (material FV /WB) for hot-dip galvanized or mill finished surface

completely hot-dip galvanized finish (alternative; mill finished tension rod), or equivalent; deliver and install according to the manufacturer's installation instructions. Includes welding the connector plates according to the specifications provided by the planner.

Tension rod system Halfen Detan-D ...

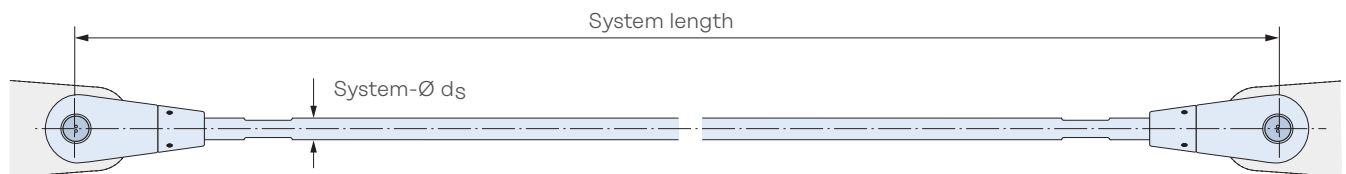

Tension rod system type Halfen Detan-D made of stainless steel, corrosion resistance class (CRC) III according to EN 1993-1-4: 2006, consisting of 1 right-hand threaded fork, 1 left-hand thread fork, plus 1 tension rod including 2 pins, 4 circlips and 2 DT-D nuts,

with European Technical Assessment ETA-23/0276, pre-assembled and product-specific-labelled tension rod system, type Halfen Detan-D, d_s , L

with

d_s = system-diameter [mm] (8 / 10 / 12 / 16 / 20 / 24 / 27 / 30)

L = system-length [mm] (from bolt-axis/to bolt-axis),

or equivalent; deliver and install according to the manufacturer's installation instructions. Includes welding the connector plates according to the specifications provided by the planner.

Halfen Detan Tension rod system

Basic system without couplers

Customer: _____ Contact name: _____
 Customer address: _____
 Tel.: _____ Fax: _____ Email: _____
 Project: _____ Project address: _____
 Date: _____ Customer no.: _____ Enquiry Estimate Order

Tension rod system Halfen Detan-S (steel):

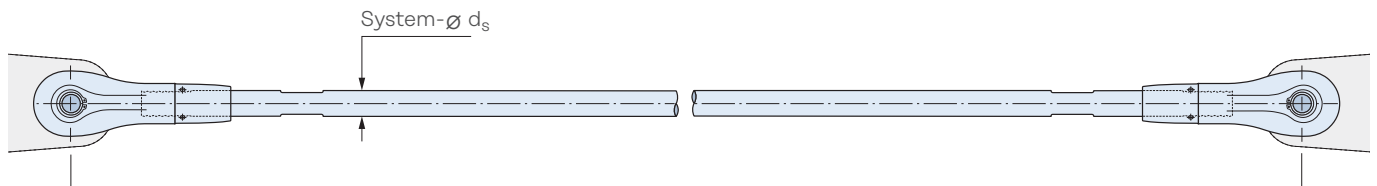

Tension rod system Halfen Detan-D (stainless):

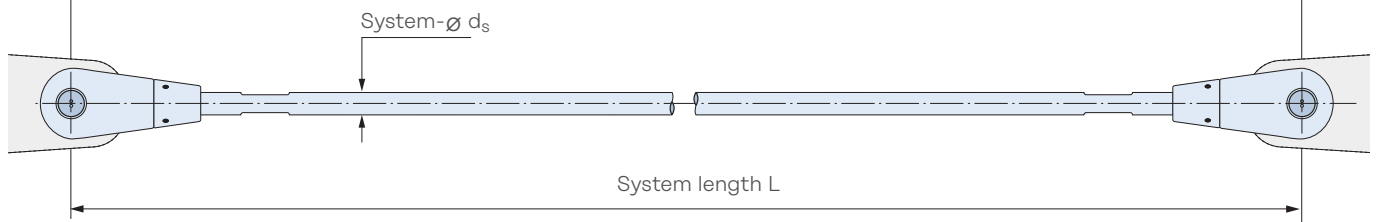

Choice of material: **Halfen Detan-S (steel)** – FV (hot-dip galvanized) ETA-05/0207; EN1993 **Halfen Detan-S (steel)** – WB (mill finish) ETA-05/0207; EN1993 **Halfen Detan-D (stainless)** ETA-23/0276

Item.	Qty	d _s [mm]	Z _{Ed,max} ① [kN]	System length L [mm]	Material choice		
					mill finish	hot-dip galvanized	stainless
Example	3	30		5600		x	

① maximum tension load required if diameter is unknown

Halfen Detan Tension rod system

Basic system with couplers

Customer: _____ Contact name: _____
 Customer address: _____
 Tel.: _____ Fax: _____ Email: _____
 Project: _____ Project address: _____
 Date: _____ Customer no.: _____ Enquiry Estimate Order

One coupler:

Example
Halfen Detan-S (steel)

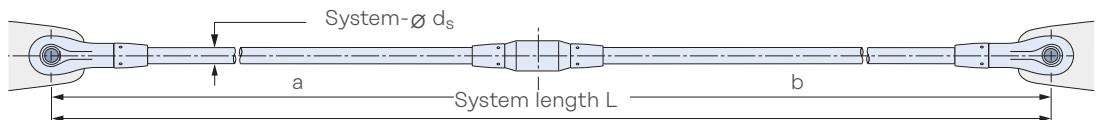

Two couplers:

Example
Halfen Detan-D (stainless)

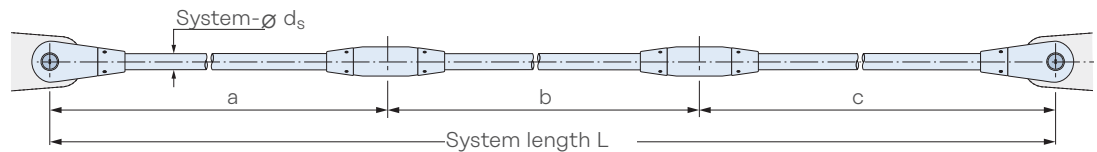

Three couplers:

Example
Halfen Detan-S (stainless)

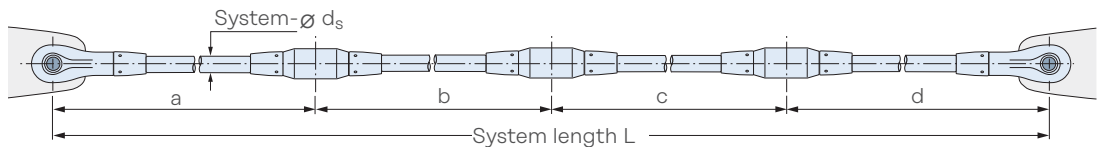

Coupler (MO)

Example Halfen Detan-D (stainless)

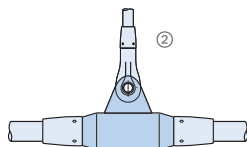

Coupler with hanger (MS)

Example Halfen Detan-S (steel)

i If more than three couplers are required, informative drawings showing the couplers locations shall be submitted. Couplers with or without hanger are available for both systems Halfen Detan-S and Halfen Detan-D.

Choice of material: **Halfen Detan-S (steel)** – FV (hot-dip galvanized) ETA-05/0207; EN1993 **Halfen Detan-S (steel)** – WB (mill finish) ETA-05/0207; EN1993 **Halfen Detan-D (stainless)** ETA-23/0276

Item.	Qty	d _s [mm]	Z _{Ed,max} ① [kN]	System length L [mm]	Qty of couplers [max.3]	Length a [mm]	MO or MS	Length b [mm]	MO or MS	Length c [mm]	MO or MS	Length d [mm]	Material choice			
													mill finish	hot-dip galvanized	stainless	
Example	3	30		5600										x		

① maximum tension load required if diameter is unknown

② suspended systems at couplers with hanger can be recorded in our order form: basic system without couplers

Halfen Detan Cross bracings

Double - symmetric fields (rectangular or square)

Customer: _____ Contact name: _____
 Customer address: _____
 Tel.: _____ Fax: _____ Email: _____
 Project: _____ Project address: _____
 Date: _____ Customer no.: _____ Enquiry Estimate Order

Cross bracing

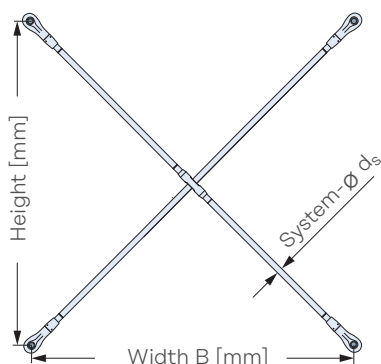

with cross couplere ②

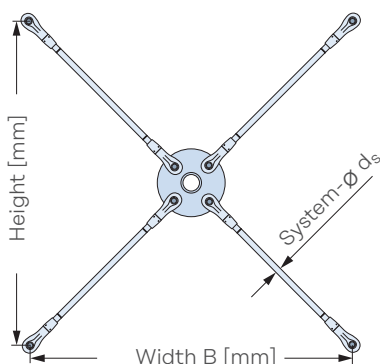

with anchor disc ②

Choice of material:

Halfen Detan-S (steel) –
 FV (hot-dip galvanized)
 ETA-05/0207; EN1993

Halfen Detan-S (steel) – WB (mill finish)
 ETA-05/0207; EN1993

Halfen Detan-D (stainless)
 ETA-23/0276

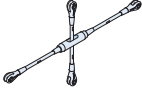
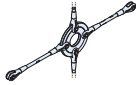
Item	Qty	d_s [mm]	$Z_{Ed,ma}$ [kN]	B [mm]	H [mm]			Material choice		
								mill finish	hot-dip galva- nized	stain- less
Example	3	30		5600	4200	x		x		

① maximum tension load required if diameter is unknown

② smallest installation angle $\alpha = 40^\circ$

Halfen Detan Cross bracings

Asymmetric fields (e.g. trapezoidal or diamond-shaped)

Customer: _____ Contact name: _____
 Customer address: _____
 Tel.: _____ Fax: _____ Email: _____
 Project: _____ Project address: _____
 Date: _____ Customer no.: _____ Enquiry Estimate Order

Cross bracing

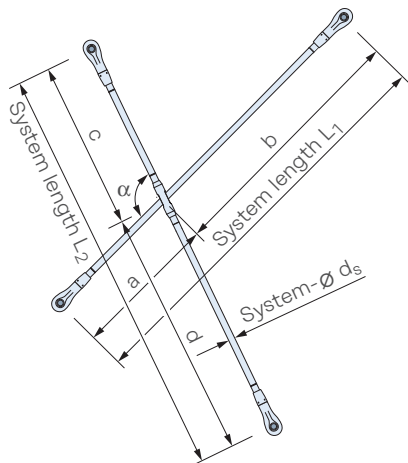

with cross coupler ②

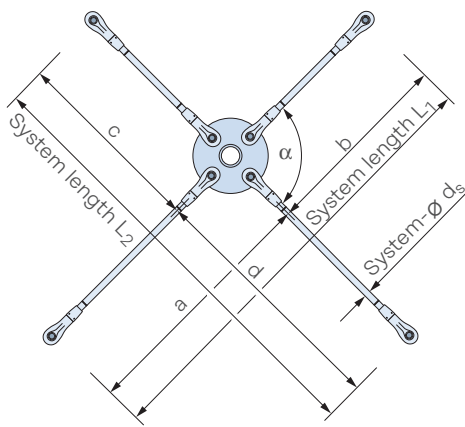

with anchor disc ②

Choice of material:

Halfen Detan-S (steel) –
 FV (hot-dip galvanized)
 ETA-05/0207; EN1993

Halfen Detan-S (steel) – WB (mill finish)
 ETA-05/0207; EN1993

Halfen Detan-D (stainless)
 ETA-23/0276

Item	Qty	ds [mm]	Z _{Ed,max} ① [kN]	System length L1 [mm]	System length L2 [mm]	Length a [mm]	Length b [mm]	Length c [mm]	Length d [mm]	Opening angle ② [°]	Material choice		
											mill finish	hot-dip galvanized	stainless
Example	3	30		5600	4200	x						x	

Plausibility check: $L_1 = a + b$ and $L_2 = c + d$

① maximum tension load required if diameter is unknown

② smallest installation angle $\alpha = 40^\circ$

Halfen Detan Compression rod system

Customer: _____ Contact name: _____
 Customer address: _____
 Tel.: _____ Fax: _____ Email: _____
 Project: _____ Project address: _____
 Date: _____ Customer no.: _____ Enquiry Estimate Order

Compression rod system Halfen Detan-S (steel):

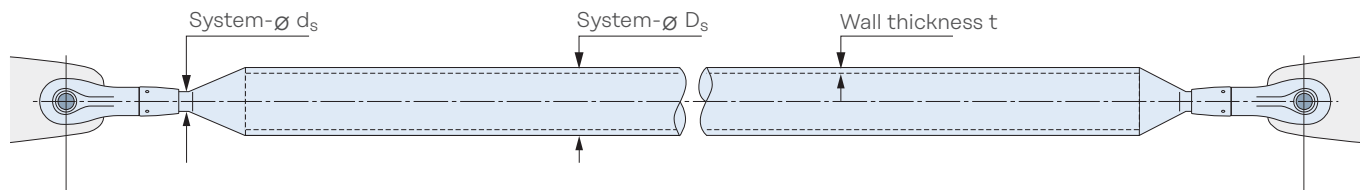

Compression rod system Halfen Detan-D (stainless):

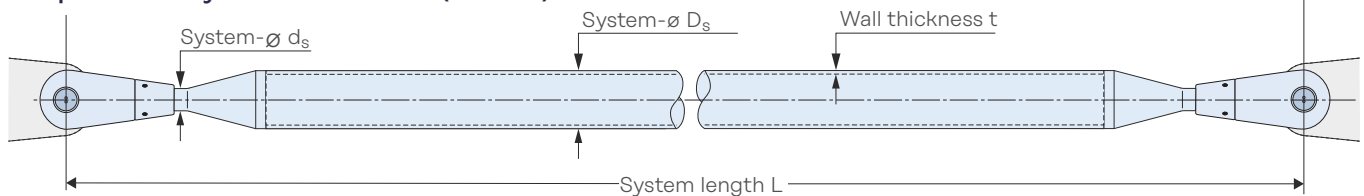

Choice of material: **Halfen Detan-S (steel)** – FV (hot-dip galvanized) ETA-05/0207; EN1993 **Halfen Detan-S (steel)** – WB (mill finish) ETA-05/0207; EN1993 **Halfen Detan-D (stainless)** ETA-23/0276

Item	Qty	d _s [mm]	D _s ③ [mm]	t ③ [mm]	N _{Ed,max} ① [kN]	Z _{Ed,max} ② [kN]	System length L [mm]	Material choice		
								mill finish	hot-dip galvanized	stainless
Example	5	16	54	2.6			1250		x	

- ① for unknown geometry maximum compression stress is required
- ② for unknown geometry maximum tension stress is required (only if present)
- ③ shorter delivery periods if standard lengths from table below will be selected (see ③ note):

i **Note:** Halfen Detan Compression rods are also available with other diameters as shown in the table.

Standard cross sections [mm]; only for steel S355								
System-ø D _s	42	54	60	76	89	114	139	
Wall thickness	2.6	2.6	2.9	2.9	3.2	3.6	4.0	

Halfen Detan Tension rod special design

Customer: _____ Contact name: _____
 Customer address: _____
 Tel.: _____ Fax: _____ Email: _____
 Project: _____ Project address: _____
 Date: _____ Customer no.: _____ Enquiry Estimate Order

Special design rod ③

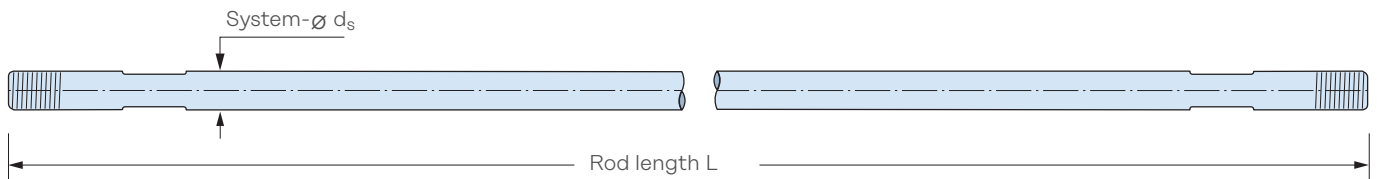

Choice of material: **Halfen Detan-S (steel) – FV (hot-dip galvanized) ETA-05/0207; EN1993** **Halfen Detan-S (steel) – WB (mill finish) ETA-05/0207; EN1993** **Halfen Detan-D (stainless) ETA-23/0276**

Item	Qty	d _s ③ [mm]	System length L [mm]	Thread design incl. indication ①② of thread-length [mm]			Fork connection single ended with thread direction ③		Material choice		
				r/r	l/l	r/l	r	l	mill finish	hot-dip galvanized	stainless
Example	3	30	2500		x			x		x	
					125	80					

① r/r = right-hand/right-hand - thread; l/l = left-hand/left-hand - thread; r/l = right-hand/left-hand - thread
 ② thread lengths up to 195 mm possible
 ③ not part of European Technical Assessment



Grønneviksøren Studenboliger
Apartment building for students
Bergen, Norway
Photos: © Cecilie Bannow





Leviat®

Innovative engineered products
and construction solutions that
allow the industry to build safer,
stronger and faster.



Contact Leviat worldwide

Australia

98 Kurrajong Avenue,
Mount Druitt, Sydney, NSW 2770
Tel: +61 - 2 8808 3100
Email: info.au@leviat.com

Austria

Leonard-Bernstein-Str. 10
Saturn Tower, 1220 Wien
Tel: +43 - 1 - 259 6770
Email: info.at@leviat.com

Belgium

Industrielaan 2
1740 Ternat
Tel: +32 - 2 - 582 29 45
Email: info.be@leviat.com

China

Room 601 Tower D,
Vantone Centre
No. A6 Chao Yang Men Wai Street
Chaoyang District
Beijing P.R. China 100020
Tel: +86 - 10 5907 3200
Email: info.cn@leviat.com

Czech Republic

Pekařská 695/10a
155 00 Praha 5
Tel: +420 - 311 - 690 060
Email: info.cz@leviat.com

Finland

Vädursgatan 5
412 50 Göteborg / Sweden
Tel: +358 (0)10 6338781
Email: info.fi@leviat.com

France

6, Rue de Cabanis
31240 L'Union
Tel: +33 (0)5 34 25 54 82
Email: info.fr@leviat.com

Germany

Liebigstrasse 14
40764 Langenfeld
Tel: +49 - 2173 - 970 - 0
Email: info.de@leviat.com

India

Unit S4, 902, A Wing,
Lodha iThink Techno Campus Building,
Panchpakhadi, Pokharan Road 2,
Thane, 400606
Tel: +91-022 695 33700
Email: info.in@leviat.com

Italy

Via F.lli Bronzetti 28
24124 Bergamo
Tel: +39 - 035 - 0760711
Email: info.it@leviat.com

Malaysia

28 Jalan Anggerik Mokara 31/59
Kota Kemuning,
40460 Shah Alam Selangor
Tel: +603 - 5122 4182
Email: info.my@leviat.com

Netherlands

Oostermaat 3
7623 CS Borne
Tel: +31 - 74 - 267 14 49
Email: info.nl@leviat.com

New Zealand

246D James Fletcher Drive, Otahuhu,
Auckland 2024
Tel: +64 - 9 276 2236
Email: info.nz@leviat.com

Philippines

27F Office A, Podium West Tower,
12 ADB Avenue, Ortigas Center
Mandaluyong City, 1550
Tel: +63 - 2 7957 6381
Email: info.ph@leviat.com

Poland

Ul. Obornicka 287
60-691 Poznań
Tel: +48 - 61 - 622 14 14
Email: info.pl@leviat.com

Singapore

10 Benoi Sector,
Singapore 629845
Tel: +65 - 6266 6802
Email: info.sg@leviat.com

Spain

Poligono Industrial Santa Ana
c/ Ignacio Zuloaga, 20
28522 Rivas-Vaciamadrid
Tel: +34 - 91 632 18 40
Email: info.es@leviat.com

Sweden

Vädursgatan 5
412 50 Göteborg
Tel: +46 - 31 - 98 58 00
Email: info.se@leviat.com

Switzerland

Grenzstrasse 24
3250 Lyss
Tel: +41 (0)800 22 66 00
Email: info.ch@leviat.com

United Arab Emirates

RA08 TB02, PO Box 17225
JAFZA, Jebel Ali, Dubai
Tel: +971 (0)4 883 4346
Email: info.ae@leviat.com

United Kingdom

President Way,
President Park,
Sheffield S4 7UR
Tel: +44 - 114 275 5224
Email: info.uk@leviat.com

USA / Canada

6467 S Falkenburg Road
Riverview, FL 33578
Tel: (800) 423-9140
Email: info.us@leviat.us

For countries not listed
Email: info@leviat.com

Notes regarding this document

© Protected by copyright. The information in this publication is based on state-of-the-art technology at the time of publication. In every case, project working details should be entrusted to appropriately qualified and experienced persons. Leviat shall not accept liability for the accuracy of the information in this document or for any printing errors. We reserve the right to make technical and design changes at any time. With a policy of continuous product development, Leviat reserves the right to modify product design and specification at any time.

